



# ICP-MS

Inductively Coupled Plasma  
Mass Spectrometry

A Primer

# Table of Contents – ICP-MS Primer

Section 1 – Introduction to ICP-MS	1
History and Development of ICP-MS	2
Agilent Technologies - History in ICP-MS	4
Section 2 – Fundamentals of ICP-MS	5
Overview of ICP-MS Major Components	6
Hardware Design	8
Section 3 – Control of Interferences in ICP-MS	27
Introduction	28
Collision/Reaction Cell (CRC) ICP-MS	30
Octopole Reaction System	30
Section 4 – Sample Preparation and Contamination Control	37
Section 5 – Extending the Capabilities of ICP-MS	41
Liquid Sample Introduction	42
Laser Ablation	45
Other Solids Analysis Techniques	47

Section 6 – Hyphenated ICP-MS	49
GC-ICP-MS	52
LC (IC)-ICP-MS	56
CE-ICP-MS	60
Section 7 – Applications of ICP-MS	63
Environmental	64
Food and Agriculture	66
Semiconductor	67
Clinical and Pharmaceutical	69
Geological	70
Nuclear	72
Forensic	72
Chemical, Petrochemical	74
Section 8 – Operating Costs, Maintenance and Diagnostics	75
Section 9 – Legislated ICP-MS Methods	79



## Section 1 – Introduction to ICP-MS

Inductively Coupled Plasma Mass Spectrometry (ICP-MS) was developed as a commercial analytical technique in the early 1980's and has since been applied to the determination of trace, minor and major elements in almost every analytical field. Strengths of the technique include:

- **Wide elemental coverage** - virtually all elements can be measured by ICP-MS, including alkali and alkaline earth elements, transition and other metals, metalloids, rare earth elements, most of the halogens and some of the non-metals
- **Performance** - high sensitivity and low background signals combine to give very low detection limits (sub-ng/L – parts-per-trillion (ppt) in most cases)
- **Fast analysis times** – with a high speed scanning quadrupole analyzer, measurement of a full suite of elements takes only about 4 minutes per sample
- **Wide analytical working range** – up to 9 orders in a single acquisition
- **Isotopic information**
- **Excellent chromatographic detector**

In the range of atomic spectrometry techniques used in analytical laboratories, ICP-MS holds a unique position by virtue of its speed, sensitivity, dynamic range and elemental

coverage, see Table 1. It can be considered as a viable alternative to ICP-Optical Emission Spectroscopy (OES) (also known as Atomic Emission Spectroscopy or AES) for fast measurement of higher concentration elements ( $\mu\text{g/L}$  to  $\text{mg/L}$  or parts-per-billion to parts-per-million concentrations). At the same time, ICP-MS rivals or, in many cases, exceeds the detection capability of Graphite Furnace Atomic Absorption Spectroscopy (GFAAS) for the determination of trace and ultra-trace elements ( $\text{ng/L}$  or ppt concentrations).

ICP-MS can measure a full suite of elements in a single multi-element acquisition, accepts almost any sample type and also provides isotopic information. One of the fastest growing areas of ICP-MS is in speciation measurement: the combination of chromatographic techniques with ICP-MS as a detector to determine the chemical form of elements in the sample. These capabilities help to explain the widespread acceptance of ICP-MS across all industry types, and confirm the status of ICP-MS as the premier technique for trace metals measurement.

Over the next few years, ICP-MS will continue to grow at the expense of other techniques listed in Table 1, as demands for more sensitive measurement with higher productivity continue to increase.

## History and Development of ICP-MS

### Beginnings

Dr Alan Gray of Applied Research Laboratories in Luton, UK, conducted much of the early research work that led to the commercial development of ICP-MS instrumentation. Initially working with a capillary direct current (DC) arc plasma coupled to a quadrupole mass spectrometer, he published early results and the first mass spectra acquired from a plasma, in a paper in 1975 [1]. This work stimulated research into the use of inductively coupled radio frequency (RF) plasmas (ICP's), with some of the key developments taking place in the lab of Velmer Fassel at Iowa State University in collaboration with Dr Gray in 1978.

**Table 1. Comparison of atomic spectrometry techniques**

TECHNIQUE	METALS	APPROX DL RANGE	ADVANTAGES	DISADVANTAGES
ICP-MS	Most metals and non-metals	ppt	Rapid, sensitive, multi-element, wide dynamic range, good control of interferences	Limited total dissolved solids (TDS) tolerance
ICP-OES	Most metals and some non-metals	mid ppb to mid ppm	Rapid, multi-elemental, high TDS tolerance	Complex interferences, relatively poor sensitivity
GFAA	Most metals (commonly Pb, Ni, Cd, Co, Cu, As, Se)	ppt	Sensitive, few interferences	Single element technique, limited dynamic range
Hydride AA	Hydride forming elements (As, Se, Ti, Pb, Bi, Sb, Te)	ppt to ppb	Sensitive, few interferences	Single element, slow, complex
Cold Vapor Mercury	Hg	ppt	Sensitive, simple, few interferences	Single element, slow

### First Commercial Instruments

An important publication by Houk et al. [2] in 1980 demonstrated the possibilities offered by the ICP-MS technique, and the first commercial systems followed in the early 1980's.

These systems were derived from parts of two existing technologies – the argon ICP, already in use in ICP-OES, and the quadrupole mass spectrometer, then being applied in fields such as Gas Chromatography Mass Spectrometry (GC-MS) and residual gas analysis. Some changes were necessary to allow the ICP to operate in physical contact with the grounded spectrometer interface, but the characteristics of these existing technologies were well matched and the performance of the first systems was impressive. Although the early ICP-MS systems were expensive, large, complex, had limited automation and tended to suffer from significant signal drift, the obvious benefits of a multi-element technique with low limits of detection and a simple mass spectrometric data output (including isotope ratio information) led to acceptance

of the fledgling technique, particularly among those involved in research and geological applications. Application of the technique in laboratories where reliability, stability and automation were a high priority, led to rapid improvement of the commercial instruments and ultimately to the small, reliable, stable and highly automated systems available today. ICP-MS systems with magnetic sector and time-of-flight mass analyzers have also been commercialized, but the quadrupole-based systems remain the configuration of choice by a very wide margin. Since the first commercial ICP-MS systems were launched, major developments have occurred in sample introduction, plasma efficiency, ion transmission, interference removal and dynamic range. Even so, the major components of a modern ICP-MS instrument can be traced directly back to the earliest systems, illustrating how inspired the original concept was.

### References

- 1 Gray, A. L., 1975, *Analyst*, 100, 289-299
- 2 Houk, R. S., Fassel, V. A., Flesch, G. D., Svec, H. J., Gray, A. L and Taylor, C. E., 1980, *Anal. Chem.*, 52, 2283-2289

## Agilent Technologies - History in ICP-MS

### First Benchtop ICP-MS

In the early 1990's, a joint venture between Hewlett-Packard and Yokogawa Electric in Japan created Yokogawa Analytical Systems. Yokogawa had introduced the world's first computer controlled ICP-MS in 1987 in Japan. By combining Yokogawa's innovative developments in ICP-MS with Hewlett-Packard's expertise in mass production and miniaturization of quadrupole mass spectrometers, the HP 4500 ICP-MS was created and introduced in 1994. The 4500 was the first benchtop ICP-MS and included numerous technological advances including ShieldTorch technology, off-axis ion lens, all solid state RF generator, Peltier cooled spray chamber and the highest frequency quadrupole of any ICP-MS. The 4500 dominated the demanding semiconductor market worldwide because of the ability of the ShieldTorch System to reduce argon-based interferences and allow measurement of K, Ca and Fe at ppt levels. The robustness and ease of use of the 4500 also ensured its adoption into routine environmental laboratories worldwide. By 1998, the 4500 was the #1 selling ICP-MS worldwide, with over 750 units shipped by 1999. Contributing to success of the 4500 model in the environmental market were the Integrated Sample Introduction System (ISIS), and Intelligent Sequencing, which automated many of the sample preparation and quality assurance/quality control (QA/QC) requirements of the commercial laboratory.

### Era of Collision/Reaction Cell Systems

Agilent began investigating the performance of collision/reaction cells (CRC) in ICP-MS in 1997. At the time the first commercial CRCs were launched in the late 1990s, Agilent were concentrating their development on a system suitable for routine analysis, especially for unknown samples. The result was the Agilent 7500c introduced in January 2001.



HP 4500 - the first benchtop ICP-MS. Hewlett-Packard Analytical Instruments Division formed part of Agilent Technologies in 1999.

It incorporated a passive type (no scanning voltage used) CRC cell – an Octopole Reaction System (ORS) for simple removal of interferences in complex matrices. Side reactions between cell gases and the analyte were eliminated with the ORS using only pure He in collision mode – made possible by the narrow ion energy distribution delivered by the ShieldTorch System.

Further development in the field of CRC technology resulted in the introduction in 2003 of a new, high sensitivity reaction cell system (7500cs) designed for semiconductor and research use. In 2004 Agilent launched a successor to the 7500c, the 7500ce, with higher sensitivity and designed for the analysis of high matrix samples in environmental, clinical and other key industries. In 2005, Agilent introduced an optional 3rd cell gas line to further expand the applicability of the ORS to research applications. With the analytical advantages of the ORS recognized by analysts worldwide it has grown in popularity: by 2005 over 85% of all Agilent 7500 Series sold were ORS systems.



Agilent 7500 Series ICP-MS



## Section 2 – Fundamentals of ICP-MS





# Overview of ICP-MS

## Major Components

**An ICP-MS instrument consists of several distinct parts:**

- Sample introduction
- Ion generation in the ICP
- Plasma/vacuum interface
- Ion focusing
- Ion separation and measurement

**Sample introduction:** The sample is typically introduced into the Inductively Coupled Plasma (ICP) as an aerosol, produced by passing the liquid sample through a simple pneumatic nebulizer. Larger aerosol droplets are removed from the gas stream by a spray chamber, and the remaining smaller droplets are swept into the central channel of the argon plasma. The Agilent 7500 Series is fitted with a Scott-type double pass spray chamber manufactured from high-purity quartz. Spray chamber temperature is precisely maintained with a thermoelectric (Peltier) device to prevent signal drift caused by large changes in room temperature and also to reduce solvent loading on the plasma. This reduced solvent loading leads to a higher plasma temperature, reducing oxide interferences, and assisting in matrix decomposition.

**Ion generation in the ICP:** The sample aerosol is passed into the plasma, which is generated in a stream of argon (Ar) contained in a quartz tube or "torch". The torch is located in the center of a cooled copper coil, through which a high power, high frequency electric current is passed. The intense magnetic field created by the electric current causes collisions between free electrons and Ar atoms, producing ions and more electrons, until a stable, high temperature plasma is formed. The high frequency current is produced by a radio frequency (RF) generator operating at powers up to 1600W. While two RF frequencies are approved for ICPs, 40.68 MHz and 27.12 MHz, the latter has been shown to result in higher plasma temperatures and is used in most modern and all Agilent ICP-MS instruments. The very high temperature of the plasma (up to 10,000K maximum and around 7,500K in the central channel) means that the aerosol droplets are rapidly dried, decomposed, vaporized and atomized, then ionized by the removal of one electron from each atom. The resulting ions, which are formed within about 10ms of the original aerosol droplet entering the back of the plasma, are present at the highest level at about 7mm from the end of the load coil, which is where the spectrometer interface is positioned.

**Figure 1:** Schematic representation of processes in ICP-MS from sample introduction to mass analysis

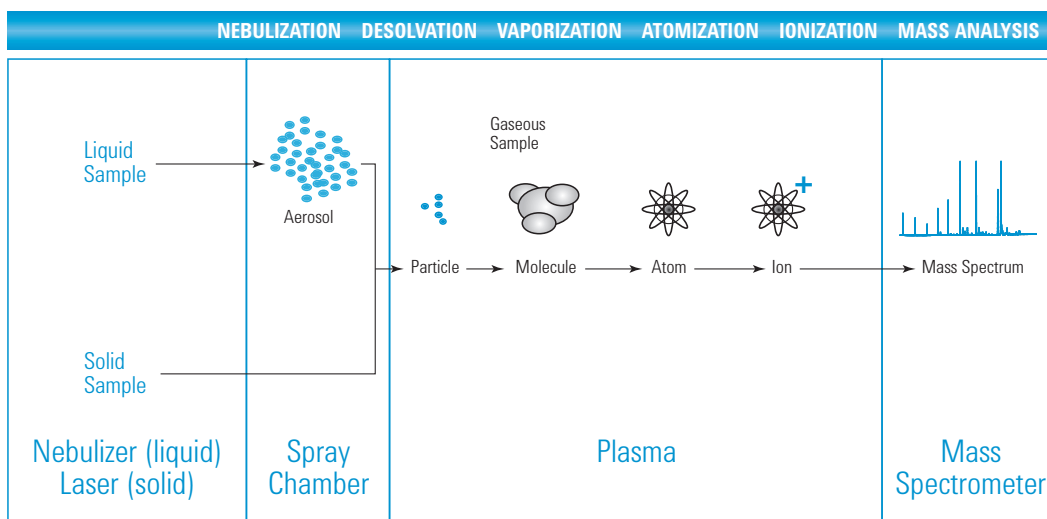

**Figure 2:** Full scan spectrum of spiked cinnamon extract showing relative abundances of elemental constituents. Enlargement shows isotopes of lead, present at 10 ppb.

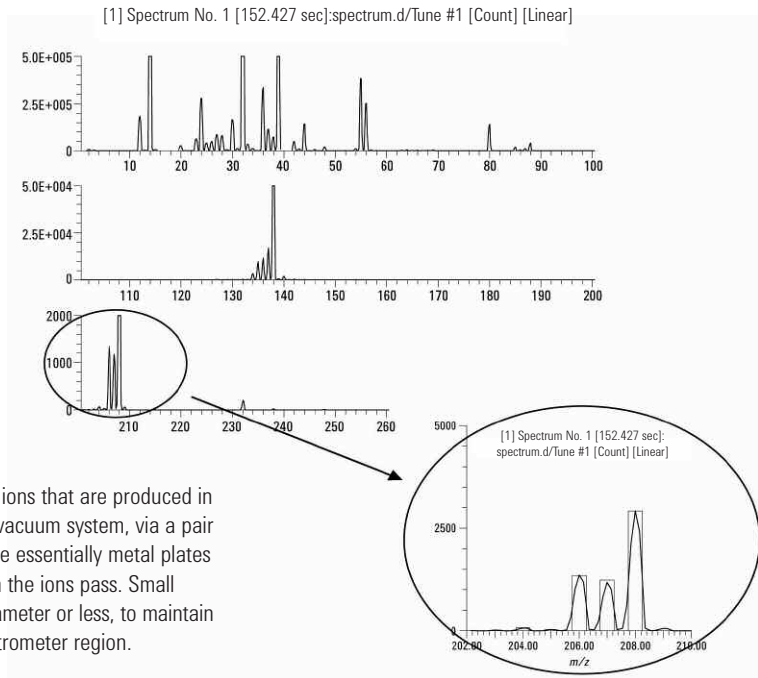

**Interface:** The positively charged ions that are produced in the plasma are extracted into the vacuum system, via a pair of interface “cones”. The cones are essentially metal plates with central orifices through which the ions pass. Small orifices are used, typically 1mm diameter or less, to maintain the high vacuum in the mass spectrometer region.

**Ion focusing:** Electrostatic lenses keep the ions focused in a compact “ion beam” as they pass through the vacuum system to the final chamber, where the mass spectrometer (MS) and detector are housed. The ion lenses perform a second, essential, function of separating the ions from the photons and residual neutral material. Agilent uses a high-transmission off-axis or Omega lens arrangement that separates the positively charged ions from the photons and neutral particles, which would otherwise reach the detector and increase random background noise.

**Mass spectrometer:** Three different types of mass analyzers have been used with ICP-MS; these are quadrupole, magnetic sector, and time-of-flight analyzers. By far the most common mass analyzer used in ICP-MS, and the one employed on the Agilent 7500 Series, is the quadrupole. The quadrupole uses a combination of DC (direct current) and AC (alternating current) electrical fields to separate ions based on their mass to charge ratio ( $m/z$ ). Since the plasma produces almost exclusively singly-charged ions, the mass/charge ratio is equal to the mass of the ion, making the spectrum very simple to interpret. The ratio of the DC and AC electrical fields is fixed but the voltages can be changed. For a given voltage setting, only one  $m/z$  is stable and the quadrupole scans rapidly across the mass range (2-260 amu), passing each mass of interest sequentially to the electron multiplier (EM) detector.

**Ion detection:** The electron multiplier detects each ion as it exits the quadrupole. The detector electronics count and store the total signal for each mass ( $m/z$ ), creating a mass spectrum (Figure 2). The spectrum that is produced provides a simple and accurate qualitative representation of the sample. The magnitude of each peak is directly proportional to the concentration of an element in a sample; quantitative results are produced by comparing signal intensities to those generated by calibration standards.

## Hardware Design

The main components of a typical commercial ICP-MS instrument – see Figure 3, are outlined in the following sections, with a brief discussion of the key parameters that affect the operation and performance of each part of the system.

- Sample Introduction
  - Overview of Nebulizers
- Plasma
  - Spectral Interferences in ICP-MS
- Interface
- Vacuum System
- Ion Focusing
- Collision/Reaction Cells
- Mass Analyzer
  - Quadrupole
  - Magnetic Sector
  - Time-of-flight (TOF)
- Detector

## Sample Introduction

The sample introduction system is one of the most important components of the entire ICP-MS system. A well-designed sample introduction system will reduce routine maintenance and enhance analytical performance. The main purpose of the sample introduction system is to convert the liquid sample into an aerosol and transport the smaller droplets efficiently into the center of the plasma, while rejecting the larger droplets, which would not be fully decomposed in the plasma.

The guiding principle for designing a sample introduction system for ICP-MS should be the maintenance of a stable, high temperature plasma. This is achieved by reducing the sample load on the plasma. A higher plasma temperature is preferable for the analysis of high matrix samples, typical of environmental, clinical, nuclear and geological applications, although a lower power (cool) plasma can be applied to the analysis of “clean” matrices, typical of many semiconductor sample types.

**Figure 3:** Schematic diagram of Agilent 7500 Series ICP-MS instrument. Depending on the model, the Omega lens or Octapole Reaction System (ORS) may be present and a single rotary pump and single, two-stage turbo molecular pump may replace the dual pumps shown.

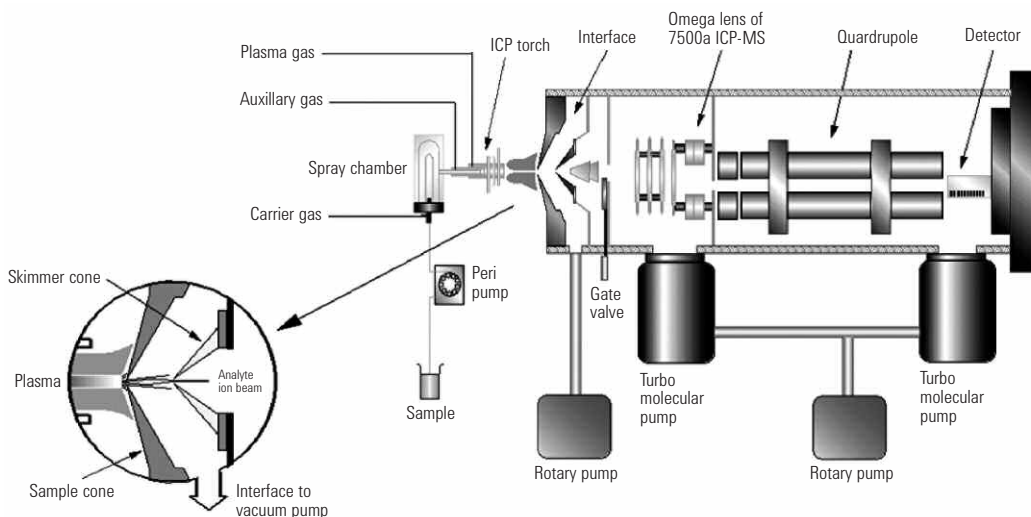

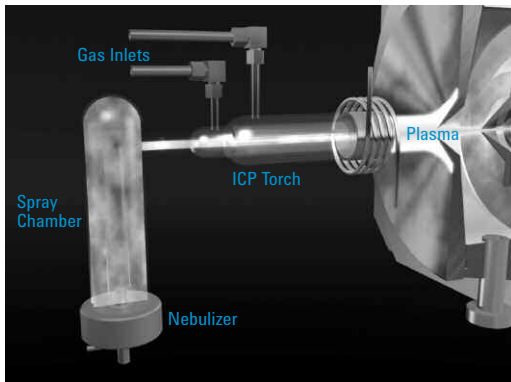

There are several factors affecting the performance of the sample introduction system:

**Nebulizer Sample Uptake Rate** - The sample uptake rate will clearly have an impact on the sensitivity of the instrument, but the relationship is not a simple one. If an ICP-MS typically operates at the uptake rates used in ICP-OES (1-1.5 mL/min), potential sensitivity should be higher, but so will water loading on the plasma, reducing plasma temperature. For this reason, the Agilent 7500 Series is optimized to run routinely at very low sample uptake rates. With a conventional nebulizer such as a Concentric or Babington design, the 7500 Series operates at 0.4 mL/min uptake rate, while maintaining high sensitivity. Most ICP-MS will operate at low uptake flows, but with reduced efficiency and signal loss, compared to the standard specifications with a high flow rate nebulizer. High efficiency nebulizers (such as the Agilent Micro Flow) deliver equivalent or better sensitivity at much lower flow rates (typically around 0.1 mL/min or less) than conventional designs due to their greater efficiency.

**Nebulizer Type** - The function of the nebulizer is to create an aerosol with uniformly small droplet size, since only the small droplets are transported to the plasma. Consideration must also be given to the sample volume available (very small samples may require the use of a low sample flow rate to give a long enough period of aspiration for the measurement to be completed), the sample type (e.g. corrosive or viscous), the flow rate delivered by the sample introduction system (e.g. an HPLC pump) and the washout characteristics of the uptake tubing. Different nebulizers optimize at different sample flows, vary in their tolerance of both suspended and dissolved solids, tolerate strong acids, bases or organic solvents differently and may have different sample memory characteristics. Another consideration is the capacity for self-aspiration. Some nebulizers do not require the sample to be pumped, which can reduce the possibility of sample contamination from peristaltic pump tubing, but self-aspiration flows are very much a function of sample viscosity. As a result, no single nebulizer type is ideal for all applications. For example, for typical environmental applications, a high efficiency, high solids nebulizer is usually the best choice, whereas a high sensitivity, micro concentric is suited to semiconductor applications.

Although there is a wide range of nebulizers available from manufacturers and specialist companies, we will consider three nebulizers which commonly meet the application needs outlined above. They are the Babington, Micro Flow, and Concentric. Each has its own merits.

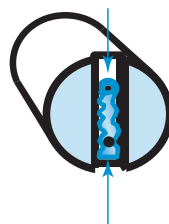
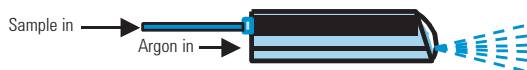

**Figure 4:** Schematic of Agilent High-Solids Babington nebulizer

**Babington-type Nebulizer** - designed for high solids applications, see Figure 4. Since the sample capillary does not contain any restrictions to flow, this nebulizer is very difficult to block. Since there is no jet or area of rapid sample pressure change, the nebulizer also does not accumulate salts and clog with high dissolved solids samples. The Agilent High Solids Babington-type nebulizer is constructed of PEEK (polyether ether ketone) and is resistant to most acids, bases and organic solvents. It optimizes at moderate flows between 0.4 and 1.0 mL/min, but does not self-aspirate. It is recommended for the highest matrix sample types, or samples containing high particulate levels.

**Concentric Nebulizer** - The glass concentric (such as the Glass Expansion MicroMist nebulizer) is capable of operating at a flow rate down to 0.1 mL/min (depending on the model), see Figure 5. It can handle TDS levels up to 15% (which is much higher than the ICP-MS can handle), and will self-aspirate, so the MicroMist offers high performance in terms of good precision, a stable signal, low % RSD and rapid sample wash-out.

**Micro Flow Nebulizer** - a PFA (Perfluoroalkoxyethylene) polymer micro concentric nebulizer, available in 20 or 100  $\mu\text{L}/\text{min}$  versions – the 100  $\mu\text{L}/\text{min}$  version is normally used. It is designed to operate at 100  $\mu\text{L}/\text{min}$  but will perform well over the flow rate range from about 50  $\mu\text{L}/\text{min}$  up to 200  $\mu\text{L}/\text{min}$ . Advantages of the Micro Flow nebulizer are its high inertness, low internal volume and hence minimum sample memory, and very high efficiency with corresponding high sensitivity. The Micro Flow nebulizer provides the best sensitivity of all the pneumatic nebulizers. Disadvantages are related to its concentric design. Since the sample is passed through a very small diameter jet, clogging is possible from samples containing particulates. Also, for the same reason, high sample flows during uptake and rinse out are not possible due to the high back pressure of the sample jet. The Micro Flow, because it is a concentric nebulizer, is capable of self aspiration and is recommended for all semiconductor samples and many other samples where high sensitivity is required or the sample volume available is small.

**Figure 5:** Schematic of concentric nebulizer

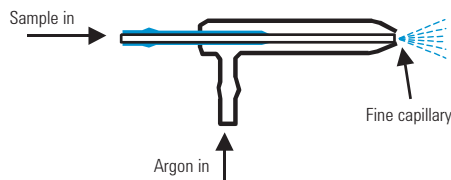

**Table 1.** Summary of merits of typical nebulizers

	BABINGTON	MICRO FLOW	CONCENTRIC
Aerosol efficiency	Medium	Excellent	Good
Dissolved solid tolerance	Excellent	Medium	Good
Self-aspiration	No	Yes	Yes

**Figure 6:** Schematic of a spray chamber

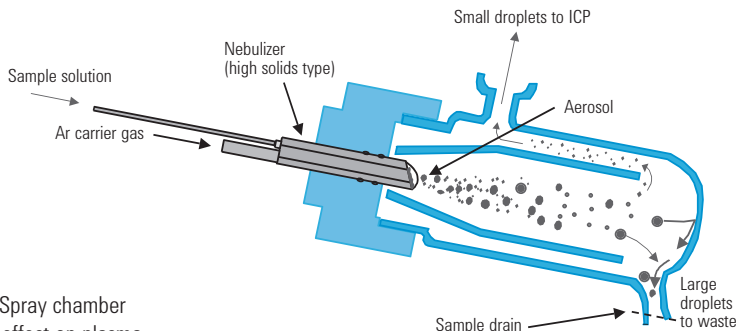

**Spray Chamber Temperature** - Spray chamber temperature can have a significant effect on plasma loading and efficiency by influencing the amount of solvent vapor entering the plasma. For this reason, it is usually desirable to operate the spray chamber lower than ambient temperature to condense the water vapor. Most modern ICP-MS instruments provide some form of spray chamber cooling to achieve this. For example the spray chamber used on the Agilent ICP-MS systems is Peltier cooled and typically maintained at 2°C for aqueous samples, see Figure 6. By comparison, ICP-OES instruments do not use spray chamber cooling since the advantages of a hotter plasma (due to reduced sample loading from a cooled spray chamber) do not apply here. Electronic temperature control using a Peltier device was pioneered on Agilent ICP-MS systems, and has now become the standard method for spray chamber cooling in ICP-MS. It reaches temperature much faster (1-2 minutes) and heat transfer is much more efficient than older refrigerated water bath systems. Peltier cooling avoids the need for fragile water jacketed spray chambers that require a separate external chiller. For volatile organic samples, spray chamber cooling is essential to maintain a stable plasma and requires the spray chamber to be maintained at a lower temperature than

with aqueous samples. Due to the high thermal transfer efficiency of a Peltier device, cooling the spray chamber to -5°C is sufficient to handle even the most volatile organics. Older recirculating bath type chillers, must be reduced to -20°C since the heat transfer and losses in the cooling pipes make these systems much less efficient.

**Spray Chamber Design** - The spray chamber must be effective at filtering out the larger sample aerosol droplets (see Figure 7) and should have a small internal volume, surface area and transfer path length to the torch, to minimize sample carryover and analyte loss by adsorption. A modified Scott-type spray chamber is generally used in ICP-MS. Cyclonic design spray chambers can also be used, and give higher sensitivity (originally developed for ICP-OES where maximum sensitivity is needed). However in ICP-MS, insufficient sensitivity is rarely a problem, and caution is needed when using cyclonic spray chambers, since they allow larger droplets to pass through to the torch, which increases plasma loading.

**Figure 7:** Droplet size distribution with and without a spray chamber

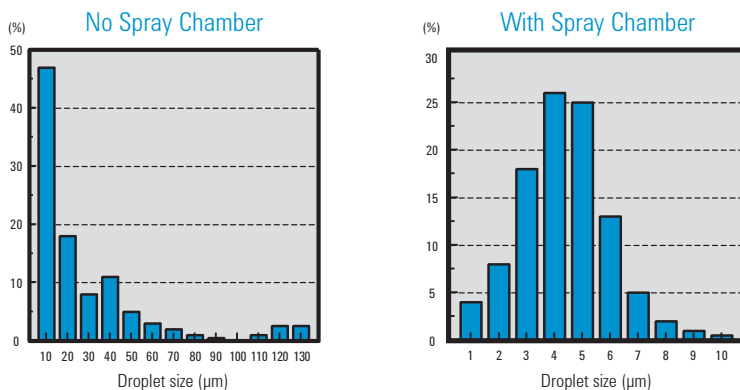

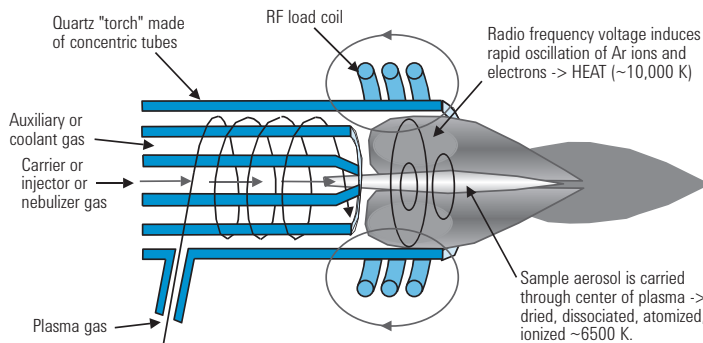
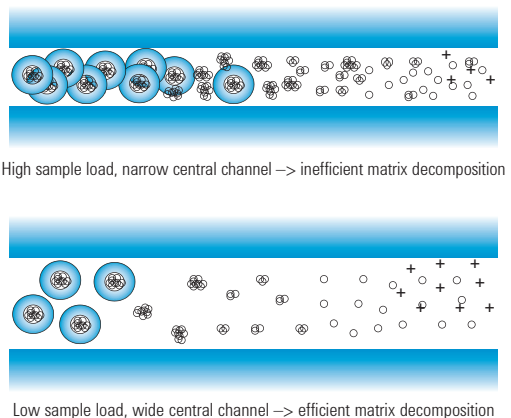

**Figure 8** ICP-MS plasma torch based on the Fassel design

**Plasma Torch Design** - The plasma torches used in ICP-MS instruments are typically based on the Fassel design previously used in ICP-OES systems, see Figure 8. The torches vary in the internal diameter of the central (carrier or injector) gas tube, which affects both the aerosol density in the plasma central channel and the velocity of the carrier gas flow. For a given gas flow rate and aerosol loading, a larger injector diameter will give a more diffuse and slower moving aerosol, both of which lead to improved matrix decomposition. Generally, the larger the injector, the lower the sensitivity. However, it is often worth sacrificing sensitivity for increased matrix tolerance and reduced deposition on the interface. The largest injector diameter currently used in ICP-MS is 2.5mm (standard on the Agilent 7500 Series), which gives maximum robustness and lowest matrix interferences. The exception to this rule is when volatile organic solvents are analyzed. In that case, small injectors (1.0mm or 1.5mm) are used to reduce plasma loading and improve plasma stability.

Figure 9 illustrates the improvement in matrix decomposition, which is obtained by reducing the sample flow, maintaining a high plasma temperature and producing a diffuse aerosol with a long plasma residence time. As well as much more efficient conversion of atoms into ions, the problem associated with poorly decomposed material passing into the interface region can be reduced.

**Ease of Access** - Since the sample introduction system is subject to exposure to harsh chemicals and mechanical wear, there is an important requirement for easy maintenance. Therefore, easy access to the sample introduction hardware has a major impact on routine maintenance operations. If the spray chamber or torch are difficult to remove, or complicated to dismantle and reassemble for cleaning, maintenance will take longer and the possibility of damage to the glassware will increase.



**Figure 9:** Effect of injector diameter on matrix decomposition

## Plasma

In the simplest terms, the purpose of the plasma is to form positively charged ions from the sample aerosol. To ensure good results from samples with high or varying matrices, plasma loading should be optimized to maintain high ionization temperatures while retaining good sensitivity. The goal is to achieve as high a degree of matrix decomposition and analyte ionization as possible. Efficient matrix decomposition reduces deposition on the interface and contamination of the expansion stage pump oil. A well optimized and high temperature plasma greatly improves sensitivity for elements such as Hg, Be and As which have high ionization potentials. Good plasma design is key to achieving the above two goals.

The basic steps of ion production in an ICP (Figure 1) are:

- Sample droplets approach the plasma and are dried
- The dried sample particles are decomposed by the plasma to produce atoms (atomization)
- At this point (atomization stage), the process is optimized for ICP-OES. In ICP-OES, emitted light is measured from excited atoms as these lines are typically more stable.
- ICP-MS measurement requires an extra step: the atoms must be ionized, since the mass analyzer can only separate ions. Thus the ICP in ICP-MS is an ion source - this requires more energy.

The formation of ions from the sample atoms is achieved by the removal of a single electron. This occurs with varying ease and efficiency for different elements. This variation is usually quoted as the "Ionization Efficiency" for each element, which is a function of the first ionization potential of the element (the energy required to remove one electron from a neutral atom), together with estimated values for plasma electron temperature and density.

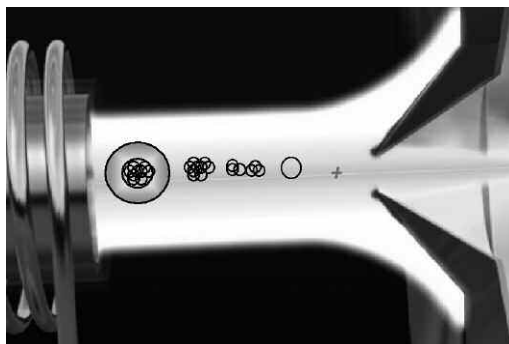

The **ionization potential** is specific for each element, but the plasma temperature is highly dependent on many other factors, including sample introduction conditions, so good design and optimization can benefit the analyst in the following ways:

1. A high plasma temperature will result from a sample introduction system that uses a low sample flow rate and removes water vapor from the sample aerosol (i.e. by use of a cooled spray chamber), which in turn reduces the cooling effect of the aerosol on the plasma.
2. In addition to optimization of the sample introduction system, the design of the ICP torch has a major effect. As described earlier, if a torch with a wide central (injector) tube is used, the aerosol will travel more slowly and will be more diffuse in the plasma central channel. Both of these factors allow better energy transfer from the plasma to the aerosol droplets, so the sample matrix is decomposed more efficiently and the atoms are ionized to a greater degree.
3. Increasing the distance from the load coil to the sample cone, known as the sampling depth, also increases the sample residence time in the plasma. Sampling depth is commonly increased to allow a longer time for decomposition of very high matrix samples. Most modern ICP-MS instruments allow computer control of the sampling depth.



- Some ICP generator designs are intrinsically better suited to ICP-MS by virtue of their inherent ability to couple energy into the plasma. Solid state RF generators are generally more efficient than vacuum tube based systems, typically offering up to 85% coupling efficiency compared to 55% on the older designs.
- RF generator frequency also plays a role in plasma temperature. Two RF frequencies are typically used to produce an ICP; 27.12MHz and 40.68MHz.

Samples are ionized in the central channel of the plasma, not on the outside. Electrical currents (induced by the magnetic field from the RF generator) flow more closely to the outer portions of the plasma and this is known as the "skin depth". Skin depth is inversely proportional to the square root of the frequency. The higher the frequency, the smaller the skin depth with a consequent decrease in the transfer of energy towards the central channel. This, in turn, results in a lower temperature and a lower electron density.

40.68MHz is an excellent choice for ICP-OES where stray background light must be kept to a minimum, but the higher central channel temperature produced by a 27.12MHz plasma, such as that used on the Agilent 7500 Series, gives significant performance benefits for ICP-MS. In addition to improved ionization, the hotter plasma also decomposes the sample matrix more efficiently, leading to superior tolerance to high dissolved solids and lower levels of interfering molecular ions.

### Spectral Interferences in ICP-MS

Polyatomic ions, which give rise to non-analyte peaks in the mass spectrum, are the main source of spectral interferences in ICP-MS. Consequently plasma conditions can have a major impact on the occurrence of polyatomic ions in the mass spectrum. Generally, if a high plasma temperature is maintained, most potential polyatomic interferences will be reduced, often to levels where, in practice, they become negligible. The level of polyatomic interferences can be monitored using the production of refractory oxide ions of specific elements. Cerium (Ce) is an element commonly used for this purpose as it forms a strong oxide bond and therefore has one of the highest oxide formation rates. The M-O decomposition efficiency is

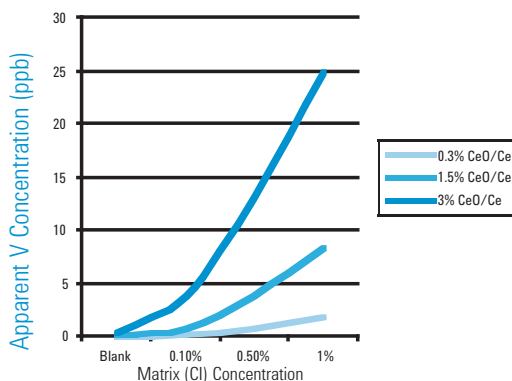
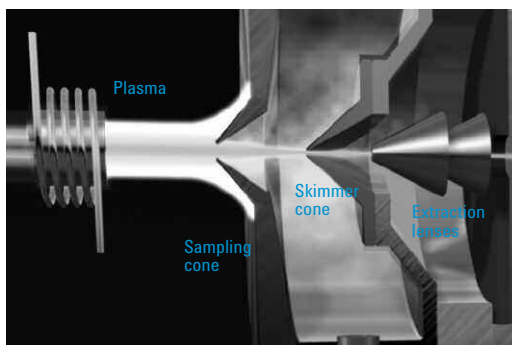

**Figure 10:** Apparent vanadium (V) concentration due to the formation of ClO interference at mass 51 with increasing Cl matrix, with an ICP-MS optimized at different CeO/Ce levels.

typically expressed as the  $\%MO^+$ , relative to the parent  $M^+$  ion, e.g. the  $CeO^+/Ce^+$  ratio. Most ICP-MS systems operate at CeO/Ce ratios of 2-3%, whereas a well-designed ICP-MS can achieve a ratio of 0.3 - 0.5% CeO/Ce – about 5-10 times lower. This translates into 5-10x lower levels for many other interferences, such as those based on matrices containing chloride and sulfate.

The reduction of ClO interference on V at mass 51 as plasma robustness is increased (lower CeO/Ce) is illustrated in Figure 10. An instrument that can be optimized at a low CeO/Ce level will significantly improve data integrity for interfered elements (almost all transition metals) in complex sample matrices, since reliance on correction equations is greatly reduced. A further benefit to operating at low CeO/Ce levels is increased sensitivity for elements with high ionization potentials such as Hg. Finally, with the advent of collision/reaction cells (CRC) for interference removal in ICP-MS, an ICP-MS that operates at low CeO/Ce levels produces less matrix interferences which means that CRC conditions may not require such highly specific optimization to give efficient interference removal.

*Refer to section on Control of Interferences in ICP-MS starting on Page 27 for a more detailed discussion on methods to overcome spectral overlaps, including the use of the Octopole Reaction System operating in helium collision mode to further reduce oxides.*



### Plasma/Vacuum Interface

The influence of good plasma/vacuum interface design on the overall performance of the ICP-MS instrument cannot be overstated. In essence, the ICP-MS interface comprises of a step-down vacuum stage, located between a pair of conical metal plates, known as interface cones, in which small orifices have been drilled. The term "interface" is applied to the cones and the enclosed space (interface or "expansion" vacuum chamber) formed between them. In common terminology, the first and second cones are referred to as the sample cone and skimmer cone, respectively. A schematic of the principal components of the 7500 Series ICP-MS interface is shown above.

The role of the ICP-MS interface is to extract a representative sample of the plasma ion population and transfer this efficiently to the higher vacuum regions in which the ion focusing, mass spectrometer and detector systems are located. This cannot be achieved efficiently with a single step from atmospheric pressure to high vacuum, so a series of vacuum chambers are used, typically 3 stages in all – see Vacuum System for more detail. The step down vacuum in the interface vacuum chamber (the first of the 3 stages) is from atmospheric pressure (approximately 1 bar) to approximately 1 mbar. This sudden pressure decrease leads to the supersonic expansion of the extracted ion beam, with the result that the composition of the ion beam is effectively "frozen" and a representative portion of the extracted plasma arrives at the skimmer cone at the back of the interface region.

The orifice size and shape of the interface cones is critical and influences many aspects of instrument performance including sensitivity, mass response, oxide and doubly charged formation and robustness to high matrix samples. Orifice size is approx. 1mm but varies between instruments. Agilent ICP-MS instruments, for example, have always used 1mm sampling cone and 0.4mm skimmer cone orifices, which provide an excellent combination of high ion transmission, low analyzer vacuum pressure and minimal transport of matrix into the high vacuum region. The use of such small cone orifices was not possible on older ICP-MS designs, until the advent of modern high efficiency plasma generators, which ensure that the interface is not exposed to high levels of undissociated sample matrix. Another drawback of using a sampling cone orifice larger than 1mm, is that gas load on the interface pump increases and the pump oil degrades more quickly.

### Vacuum System

Mass spectrometers work most efficiently at low pressure (high vacuum). The maintenance of a high vacuum in the analyzer region is essential, in order to reduce the background and scattering effects that a high level of residual gas molecules would cause. The preferred configuration in both early and current commercial instruments is for a 3 stage differentially pumped vacuum system comprising the interface, intermediate and analyzer stages at progressively lower pressures.

The typical vacuum configuration for commercial ICP-MS instruments is for the interface stage to be evacuated using a rotary vane pump, which is switched off when the ICP-MS is in "standby" mode, to allow access to the interface cones and ion lenses for maintenance. The intermediate and analyzer vacuum stages are typically pumped by two separate turbo-molecular pumps or by a single, dual-stage pump. A "backing" rotary pump removes exhaust from the turbo-molecular system.

The intermediate and analyzer vacuum stages are typically isolated from the interface region by a gate valve, which seals the high vacuum region when the interface pump is switched off. This allows routine maintenance without requiring the high vacuum pumps to be switched off, so the vacuum is maintained and start-up times are minimized. The gate valve is under pneumatic or solenoid switch control, such that any power, coolant or gas failure or plasma shutdown causes the valve to shut automatically, avoiding sudden loss of vacuum.

## Ion Focusing

Electrostatic plates, known as ion "lenses", are located within the intermediate stage. These lenses focus the ion beam as it enters the intermediate stage through the skimmer cone, and separate the analyte ions from neutral species and photons, which must be prevented from reaching the detector. In the case of collision/reaction cell (CRC) based systems (see page 17 for more detail), the CRC cell is also located in the intermediate stage. In the final, analyzer stage, the low pressure allows effective transmission of the ions through the quadrupole mass analyzer to the detector.

Most quantitative ICP-MS analysis is based on concentrations reported on a weight/weight or weight/volume basis. Since light elements have much lower mass than heavy elements, the ion populations should be in inverse proportion to the atomic mass of the element – in other words 1ug/L of Li contains many times more Li atoms than 1ug/L of U contains U atoms. This means that the ion populations in the ion beam extracted from the plasma should contain a much higher number of light ions for an equal analyte concentration. The fact that ICP-MS sensitivity is typically broadly constant across the mass range (or lower at low mass) is due to the preferential transmission of higher mass ions through the ion focusing system.

In order to prevent the loss of ions from the beam, the ion lenses are used to focus and transfer charged species efficiently to the mass spectrometer entrance aperture. While several different ion lens designs have been used in ICP-MS, the typical arrangement is to use one or more

cylindrical lenses, to which a voltage can be applied. When the positive ions generated by the plasma pass through the electrostatic field in the lens system, they are attracted to negative and repelled from positive fields, so can be manipulated in the required trajectory.

In addition to guiding and focusing the ions, the ion lens system is responsible for separating the ions (which must be transferred efficiently to the mass spectrometer for analysis) from neutral species and photons (which must be prevented from reaching the detector if the random background signal is to remain low). This is achieved by using the electrostatic fields in the lenses to deflect the ions thus separating them from the photons and neutrals (which are uncharged and so are not influenced by the field).

The ion lens system may consist of a simple, single cylindrical electrostatic lens, which has the virtue of low cost and simple operation, but has limited flexibility. Alternatively, a multi-component ion lens design may be used, which increases cost but allows greater flexibility of optimization. Early designs of lens systems utilized a grounded metal disc, known as a "photon" or "shadow" stop, on the axis of the instrument, to block the direct line from plasma to detector.

In the late 1980's, Agilent pioneered the use of an "off-axis" ion lens arrangement, as this gives higher ion transmission across a wider mass range compared to the earlier configurations. The principle of this separation of ions from neutral species is illustrated in Figure 11. Because the off-axis design does not use a photon stop, there is much

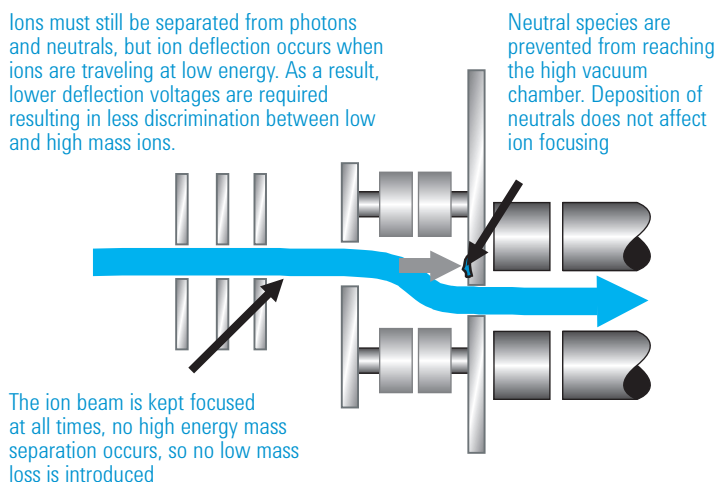

**Figure 11:** Schematic of Agilent off-axis ion lens design

higher overall ion transmission through the instrument. Secondly, the absence of a metal plate immediately behind the skimmer leads to a reduced maintenance requirement. Finally, since no defocusing voltage is applied to the ion beam, mass bias, which is characteristic of the photon stop design, does not occur, as illustrated in Figure 11.

## Collision/Reaction Cell

Collision/Reaction cells (CRC's) are a means to remove spectral interferences in ICP-MS and have been incorporated into instruments since the late 1990's. They have become so powerful and popular that most ICP-MS sold since the early 2000's are equipped with a CRC. There are different configurations of CRC but fundamentally the device consists of an ion guide, which is enclosed in a cell that can be pressurized with a gas and is located after the main ion lenses. The gas interacts with the ion beam to remove polyatomic interferences in one of two ways:

- Reaction Mode - the gas reacts with an interference to convert it to a different species.
- Collision Mode - the gas collides with the polyatomic interference, causing it to lose energy. Since polyatomic species are large, they undergo more collisions than do analytes, and so lose more energy. The lower energy interference is then separated from the higher energy analyte by energy discrimination (ED).

Agilent's version of the CRC is the Octopole Reaction System (ORS) see Figure 12. Such is the success of the ORS design that 85% of all Agilent ICP-MS now sold are ORS systems. CRC's have grown in importance to such an extent in ICP-MS that they are discussed separately in more detail in Section 3: Control of Interferences in ICP-MS.

## Mass Analyzer

Ions pass from the ion lens system (with or without CRC) into the final or analyzer vacuum stage, where they are separated by the quadrupole, according to their mass to charge ratio. By far the most widely used mass analyzer used in ICP-MS is the quadrupole – due to its ease of use, robustness, mass range, high scanning speed and relatively low cost. The other analyzers that have been used in ICP-MS are magnetic sector or double focusing and time of flight (TOF). Quadrupoles typically offer the ability to separate integer masses ( $M/\Delta M$  of approximately 400); however magnetic sector (also known as sector field) based filters are capable of resolution up to 10,000 and are able to resolve most polyatomic species from analytes at the same nominal mass. TOF analyzers offer very high speed scanning capability of transient signals but with lower sensitivity and less control of interferences than quadrupole and magnetic sector spectrometers.

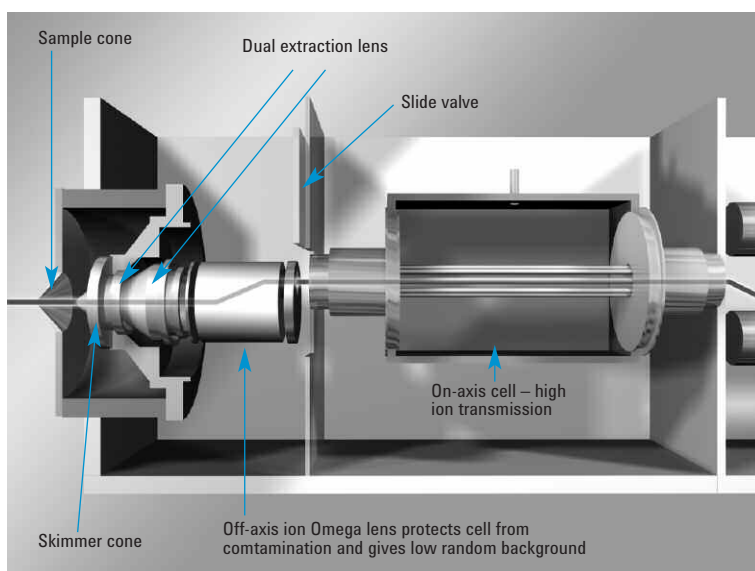

**Figure 12:** Schematic of Agilent Octopole Reaction System

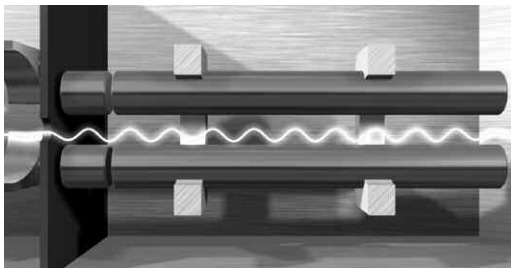

*Representation of ion path through a quadrupole mass analyzer.*

## Quadrupole

The quadrupole is a sequential mass filter, which separates ions based on their mass to charge ratio ( $m/z$ ). It comprises of two pairs of parallel cylindrical rods, arranged in a square, on the axis of the ion beam. A varying or AC voltage, operating at high frequency, plus a DC voltage is applied to the two pairs of rods. The AC (same voltage but out of phase between the 2 pairs of rods) and DC (positive on one pair and negative on the other) voltages give a dynamic hyperbolic electric field, in which any ion above or below the set mass of the quadrupole enters an unstable trajectory and is lost from the ion beam. Combining the AC and DC components produces a narrow bandpass filter that allows only a narrow range of masses to be transmitted. By varying the AC and DC fields, but keeping the ratio between them constant, different masses can be selectively allowed to pass through the filter. Since these voltages can be adjusted very rapidly, the elemental mass range from 2 to 260 amu can be scanned very quickly, giving a mass spectrum for all elements and their isotopes (Li to U), which is acquired virtually simultaneously. The full mass range is normally scanned for qualitative measurements, but the quadrupole can also be set to acquire only masses of interest, jumping between each measured mass to reduce measurement time.

The principal factors which affect the performance of the quadrupole are:

- **Scan speed** - In practice, the speed of the mass scan is not limited by the quadrupole scan rate, but is determined by the response time of the detector and the "settle time" required by the quadrupole after each mass jump. This settle time, which is typically of the order of a few milliseconds, allows the quadrupole voltages to stabilize at their new settings, prior to data collection at the new set mass. A well-designed

quadrupole controller will use a variable settle time, which automatically determines the minimum settle time needed for each measured mass, dependent on the size of the mass jump (and hence the voltage change) that preceded it.

- **Frequency of the AC voltage** - For high quality separation of ions, the varying (AC) voltage component of the quadrupole field must be operated at high frequency. Typical frequencies on commercial ICP-MS systems are in the range 2 MHz to 3 MHz. Resolving power (resolution) improves with higher frequency.
- **Scatter** - Ions traveling down the quadrupole may be "scattered" or diverted from their ideal central trajectory. This would typically be caused by an impact with a residual gas molecule or by the analyte ion entering the quadrupole with too much or too little ion energy. Ion energy in the quadrupole is controlled by the voltages applied to the ion lenses relative to the quadrupole offset voltage. Residual gas impact is minimized by ensuring that the analyzer stage has a good vacuum, which is obtained by using close-coupled turbo molecular pumps and minimizing the size of the interface orifices.
- **Electronics** - Particularly where modern components are used in the power supplies and electronics, and analyzer electronics are temperature controlled the quadrupole can achieve short and long-term signal stability to rival optical ICP spectrometers.
- **Quadrupole rod cross section and length** - The theoretically ideal field between the two pairs of quadrupole rods is hyperbolic in shape. The most efficient method of generating a hyperbolic field is to use quadrupole rods that are not round in cross-section, but profiled. However, for reasons of manufacturing costs, hyperbolic quadrupole rods are rarely used in commercial ICP-MS systems, despite their higher ion transmission and improved peak shapes. It is more usual for ICP-MS manufacturers to use the lower cost extruded, machined or molded round cross section rods, with the hyperbolic field being approximated through the use of electronics. Currently, only the Agilent 7500 Series features hyperbolic cross-section rods. The length of the quadrupole also influences resolution. To achieve good separation, ions should spend a relatively long time in the filter, so long rods with high frequency AC fields provide superior performance.

Manufacturing tolerances prevent very long rods from being practical, so most manufacturers use filters that are in the range 190 to 230mm. A useful rule of thumb for assessing quadrupole performance is to multiply the operating frequency by the length of the rods. Generally, higher values provide better performance.

As well as resolution there is another criterion that is a measure of a well designed mass filter, "abundance sensitivity". In a typical ICP-MS analysis there may well be sample components which are present at very high intensity adjacent to analyte peaks which are to be measured at trace levels. A high performance quadrupole will be able to separate these adjacent peaks without special resolution settings being required on a per-mass basis - see Figure 13. The abundance sensitivity is a measure of an analyzer's ability to separate adjacent peaks differing greatly in intensity.

On most modern ICP-MS, ion energy and quadrupole length are similar. Quadrupole operating frequency varies significantly, however, and so a higher frequency will result in significantly better abundance sensitivity in actual analysis.

Figure 14 shows the measurement of trace elements in a 1000 ppm Cu solution. The trace Ni ( $m/z$  60) and Zn ( $m/z$  64, 66) peaks are completely resolved from the very large Cu peaks at  $m/z$  63 and 65. There is no overlap of the major peaks at 63 and 65 on the adjacent, trace peaks. This spectrum, acquired on an Agilent 7500 illustrates the excellent resolution and abundance sensitivity, low random background and good peak shapes, which are characteristic of a high frequency, research-grade, hyperbolic quadrupole.

**Figure 13:** Explanation of resolution and abundance sensitivity

The diagram at right shows the meaning and importance of some of the terms commonly used in connection with quadrupoles.

Resolution is an indication of the width of an individual peak, while abundance sensitivity refers to the contribution a peak makes to its neighbors.

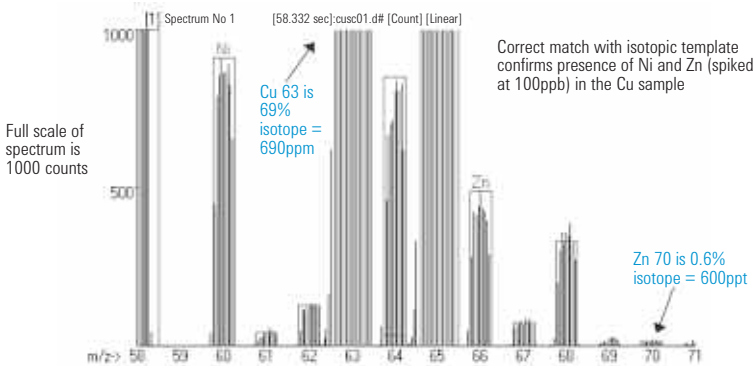
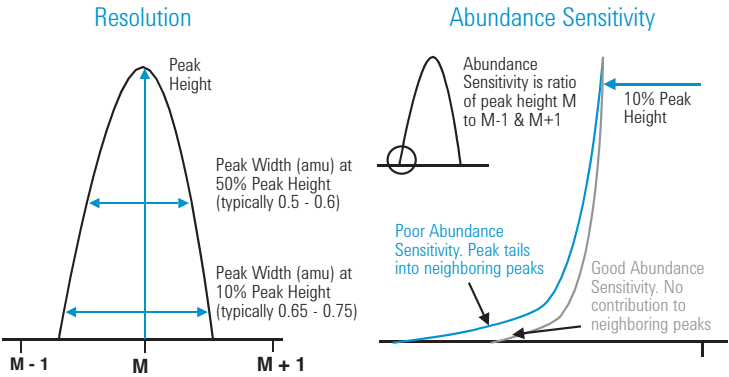

**Figure 14:** Practical example of the importance of good abundance sensitivity

Excellent abundance sensitivity ensures Cu peaks are completely resolved from trace Ni and Zn at 62, 64, 66

## Magnetic Sector or Sector Field Analyzers

While a quadrupole mass spectrometer is used in the large majority of commercial ICP-MS instruments, some systems utilize a magnetic sector analyzer, typically employed where mass resolution significantly higher than unit resolution is required. High resolution (HR), also known as sector field (SF) mass spectrometers were first introduced by VG Elemental in 1989 [1] and offered the analyst the opportunity to separate or resolve analyte peaks from polyatomic overlaps, providing improvements in detection limits and measurement certainty for some difficult applications. A resolution setting of up to 10,000 ( $M/\Delta M$ ) allows the separation of analyte/interferent pairs such as As/ArCl at mass 75 and Cr/ArC at mass 52, which are commonly reported as spectral overlaps in quadrupole-based ICP-MS instruments. Note that magnetic sector instruments cannot resolve elemental isobaric interferences (e.g.  $^{115}\text{Sn}/^{115}\text{In}$  or  $^{40}\text{Ca}/^{40}\text{Ar}$ ), which typically require much higher resolution than 10,000.

A schematic diagram of a commercial high resolution ICP mass spectrometer is shown in Figure 15. The ionization and ion sampling components of high resolution ICP-MS (HR ICP-MS) instruments are similar to quadrupole-based systems. However the ion focusing is different and relies on two analyzers – an electrostatic analyzer (ESA) and an electromagnet or magnetic sector (MS). The principles can be outlined as follows:

- Ions sampled from the plasma are first accelerated in the ion optic region before being focused into the variable entrance slits – this stage determines resolution.
- The ions then enter an electromagnet induced magnetic field which deflects different masses through different angles.
- The next step is often referred to as “energy filtering”:
  - Ions enter an electrostatic sector, where they are filtered or resolved according to their kinetic energy (energy resolution).
- Ion detection using a single detector is similar to that used on a quadrupole system whereas multiple Faraday cups are used in multicollector systems. Multicollector systems are optimized for high-precision isotope ratio analysis of a large range of elements. They operate at a maximum resolution of around 3500. These systems are not well suited to making trace concentration measurements because of poor signal to noise on the Faraday cup detectors.

A further benefit of the high-resolution approach is that the design of the curved ion flight path gives a combination of high ion transfer efficiency and very low random background (from photons and neutral species) of around 0.2 counts per second. As a result, when operated in normal unit resolution mode (“low” resolution), the

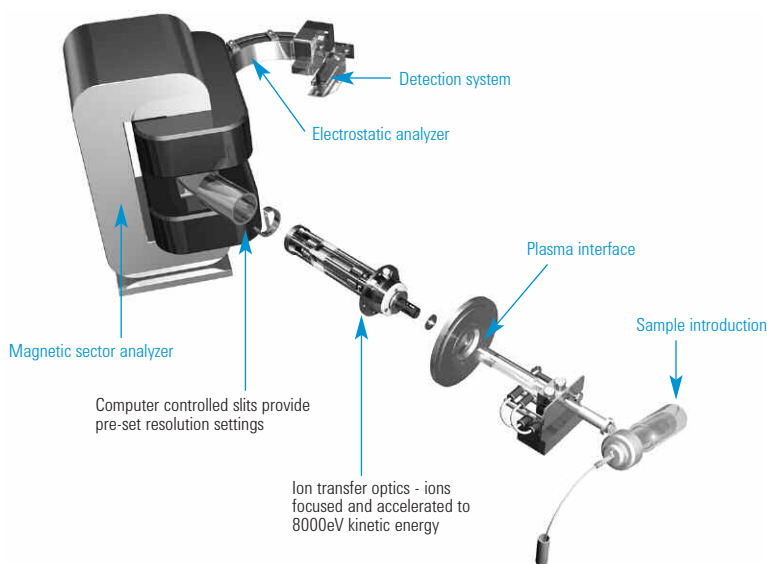

**Figure 15:** Schematic of a commercial high resolution ICP-MS instrument

(Courtesy of Thermo Finnigan)

detection limits achievable on a high resolution ICP-MS can be a factor of 5 to 10 times lower than on quadrupole based instruments – provided blank contamination can be eliminated. Sensitivity (ion transfer efficiency) does decrease significantly with increasing resolution, such that a resolution setting (R) of 4000R results in ion transmission of about 10% of that at 300R (unit mass), decreasing to only 1% transmission at 7500R. Another disadvantage of magnetic sector analyzers is that they have poor abundance sensitivity, unlike quadrupoles. This is a limitation when analyzing samples containing major peaks, like digested metals. Nevertheless the low random background and high inherent sensitivity, combined with the unequivocal separation of analytes from polyatomic interferences mean that high resolution is a valuable, if expensive tool for research applications.

As a result, HR ICP-MS instruments have been employed in applications where the requirement for improved detection limits outweighs the higher purchase cost and increased complexity and cost of ownership of such devices. Some applications, which might previously have required high resolution ICP-MS, are now being addressed using quadrupole ICP-MS instruments equipped with collision/reaction cell technology, which allows quadrupole-based instruments to address the removal of polyatomic interferences in complex matrices.

## References

1. Bradshaw, N., Hall, E. F. H. and Sanderson, N. E., 1989, *J. Anal. Atom. Spectrom.*, 4, 801-803

## Time of Flight (TOF) Mass Analyzer

In a Time of Flight (TOF) mass analyzer (see Figure 16), a uniform electrostatic pulse is applied to all ions at the same time, causing them to accelerate down a flight tube. Lighter ions achieve higher velocities and arrive at the detector first, so the mass-to-charge ratios of the ions are determined by their arrival times.

TOF analyzers have also been used in ICP-MS for applications where many masses are measured in short lived transient signals e.g. laser ablation studies. This is because the TOF mass spectrometer separates the ions and delivers all masses to the detector with a very short time delay, allowing many thousands of full mass scans to be acquired per second, giving a virtually simultaneous measurement.

But ICP-TOF-MS has not yet proved a viable alternative to ICP-QMS for routine applications, due to its limited sensitivity, inability to "skip" very high intensity background peaks and the fact that the mass calibration is dependent on the analyte ion energy, which can vary with sample matrix type, thereby limiting dynamic range and matrix tolerance.

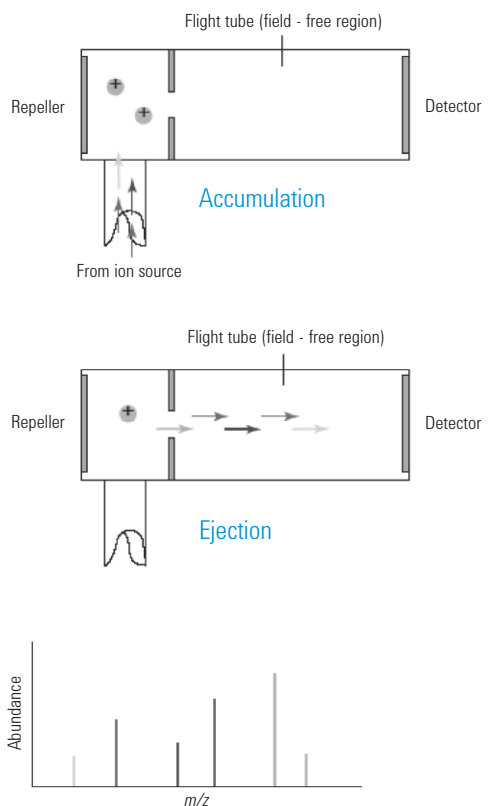

**Figure 16:** Time of Flight mass analyzer



**Figure 17:** Schematic of dual mode detector – automatic switching between pulse counting and analog mode

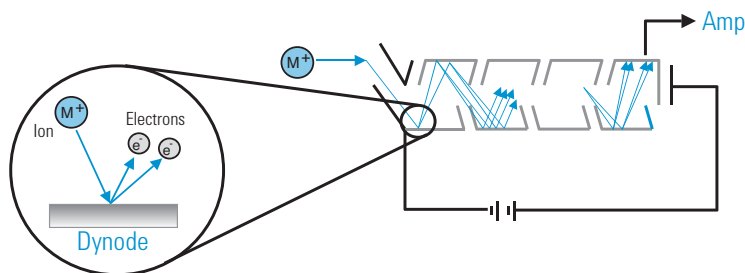

## Detector

The detector in an ICP-MS instrument is largely responsible for the characteristics of very high sensitivity and low random background, for which the technique is well known. The reason for the high sensitivity is that the detector used in virtually all modern ICP-MS instruments is a so-called "electron multiplier" device, which means that it can generate a measurable signal pulse from the impact of a single ion. To make best use of this sensitivity, it is essential that the arrival of an ion can be reliably distinguished from any random background noise arising either from the vacuum and spectrometer system or from the electronics.

The important specifications relating to the performance of the detector in an ICP-MS system are:

- High sensitivity (counts per second per unit concentration)
- Wide linear dynamic range (the concentration range over which the detector gives a linear count rate response)
- Low random background

The random background performance of an instrument is affected by the design of the plasma generator and ion lens configuration (which determine ion energy and separation of ions from photons and neutrals), as well as the analyzer vacuum and the quality of the detector electronics.

## Principles of an Electron Multiplier

As a positive ion arrives at the mouth of the detector, it is deflected onto the first dynode, which is held at a high negative voltage. The impact of the ion releases several free electrons from the dynode surface, which are repelled from the high negative voltage at the front and strike the next dynode. Each electron which strikes the second dynode releases several electrons from that surface and so on down the many stages of the detector – hence the name "electron multiplier". By the time the electron cascade reaches the final dynode, the multiplication factor has built up a pulse large enough to be measured reliably as an ion "count".

## Practical Considerations

**Dynamic Range** - Many applications require the determination of analytes at very high concentrations, sometimes several 100s of mg/L (ppm). The normally accepted limit for dissolved solids in liquid samples for analysis by ICP-MS is 0.2% or 2000 mg/L. This can be increased depending on the matrix – for example brine (NaCl) can be routinely analyzed at 1-3% by ICP-MS.

**Detector Electronics** - Although an ion counting detector is ideal for measuring low count rates, it is not suitable for very high ion count rates, as the detector becomes "saturated" and fails to register some of the ions, leading

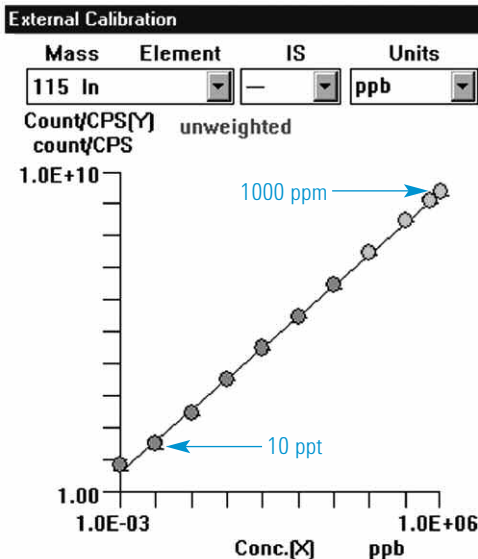

**Figure 18:** Dual mode 7500 Series calibration from 10 ppt to 1000 ppm for indium

Conventional pulse counting is used for the first 6 orders of concentration range, providing the best signal to noise and therefore the best detection limits. The addition of an analog range can provide an additional 2 (in the case of most ICP-MS instruments) or 3 (in the case of the 7500 Series) orders of magnitude dynamic range, giving a total range of 8 or 9 orders, respectively. This is illustrated in the calibration shown in Figure 18, which shows a single linear calibration for In on the 7500, from a low standard at 10 ppt to a high standard at 1000 ppm. See page 30 in Reaction and Collision Cell ICP-MS section for more information on how the Agilent Octopole Reaction System operating in gas mode can be used to further extend the linear range of elements such as Al, Na, K, Mn, etc.

With 9 orders dynamic range, the main limitations to ICP-MS measurements are now the control of blank contamination and the nominal limit on the dissolved solids levels that can be analyzed (typically 0.2% total solids). See Contamination Control section on page 39.

to a non-linear response. To overcome this problem, ICP-MS detectors have, for several years, been able to operate in "extended dynamic range" or "dual" mode, to allow the measurement of higher count rates. These dual mode detectors use pulse-counting at lower count rates (typically up to a few million counts per second - cps) and then, at high count rates, switch to analog mode, in which the current generated by the electron stream is measured, rather than the pulse that derives from each individual ion impact.

Consideration of the analog response time is particularly important for applications where short duration peaks are measured, such as chromatography or laser ablation. Poorly designed detector electronics may require an analog dwell time of several milliseconds, as compared to 0.1ms time for pulse-counting. Well-designed detector electronics should allow the same short dwell time to be used for both detector modes, so the scan speed is not compromised when there is a requirement to measure both low and high concentrations in a sample.

## ICP-MS Data Handling

### Data Acquisition and Interpretation

The quadrupole ICP-MS is suited to scanning rapidly across the mass range, building up a mass spectrum by collecting data during multiple "sweeps" over the masses of interest. Commercial ICP-MS instruments typically provide the operator with a range of measurement strategies, such as "scanning", where a mass range is defined and the quadrupole steps sequentially across all masses in the range, and "peak jumping" (or "hopping"), where the operator selects the actual isotopes to be measured and the intervening masses are "skipped" (not acquired).

In general terms, scanning may be the most suitable acquisition method for screening of unknown samples, where the composition of the sample matrix is unknown and the presence of potential analytes may need to be confirmed through the comparison of the measured isotopic pattern against a reference database of the theoretical isotope pattern for the analyte. Peak jumping is typically used when the target analytes are known and additional information is not required (the presence of other analytes, for example).

Alternative measurement protocols include:

- Single ion monitoring (where the quadrupole mass is static and data are collected against a time scale) – not commonly used.
- Time resolved analysis (where several masses are measured as a function of time).
- Isotope ratio measurements (where the quadrupole sweeps rapidly between two or more isotopes of the same element, to provide a precise ratio of the isotopic abundances).

**Time Resolved Analysis (TRA)** is used when the signal of interest for one or more elements changes with time. Typical applications include the separation and analysis of elemental species using a chromatographic step prior to the ICP-MS measurement, and the monitoring of the signal for specific elements as they vary with time and sampling position in Laser Ablation (LA) ICP-MS analysis.

**Isotope ratio measurements** are used both for isotopic analysis itself and for isotope dilution, which is used to quantify elements based on the change in ratio that results from the spiking of an unknown sample with a spike enriched in one isotope of the target analyte.

In all cases, the ions that are transmitted by the quadrupole reach the detector and generate a signal, which is integrated, stored and calibrated against a reference signal (usually from a standard material). The instrument software provides a range of options for processing the raw count-rate data measured at the detector, and a range of calibration options for converting the measured counts into analytically useful concentration or ratio results.

### Calibration and Quantification

Typical ICP-MS quantification methods include:

- External calibration (with or without internal standardization)
- Method of Standard Additions
- Semi-quantitative analysis
- Isotope ratio measurements
- Isotope dilution (IDMS)

The most typical quantification method used with ICP-MS measurements in liquid samples is **external calibration**. In this method a calibration plot is constructed, based on the measured signal for the elements of interest against their concentration in a known solution. The known solution is typically prepared from single or multi-element stock solutions, but reference materials can also be used, provided the reference values are sufficiently well defined to act as a calibration standard. In theory, single point (plus a blank) calibrations could be used, since the response of ICP-MS is linear with concentration but, in practice, several standards (typically 3 to 5 standards, plus a calibration blank solution) are normally used to define the calibration plot in the concentration range of interest. Internal standards are commonly used in ICP-MS, particularly where samples vary in composition from the calibration standards, since changes in sample transport, nebulization efficiency and long-term drift would all lead to errors, which may be corrected if an element with similar behavior is used as a reference.

A variation on the external calibration method called **Standard Addition, or Method of Standard Additions (MSA)** is commonly used when high purity materials are analyzed, such as the process chemicals used in the semiconductor industry. MSA uses the same sort of synthetic elemental calibration standard mix as external calibration, but the calibration solution is spiked at multiple levels directly into the unknown sample, giving a calibration of response against added concentration, rather than response against absolute concentration. The added concentrations give the slope of the calibration line for each element. The concentration of the unspiked sample can be read directly from the x-axis intercept of the calibration curve.

ICP-MS is ideally suited to **semi-quantitative (SQ) analysis**, in which a reference element is used to "calibrate" the measured signal from another element, to provide an estimate of the concentration of the second element, after correction for the instrument mass bias, the abundance of the isotope measured and any variation in the ionization efficiency of the element. Table 1 summarizes the results from the SQ analysis of NIST 1640 standard reference water. Note the dynamic range of the instrument, with data quantified at both sub ppb and ppm levels. Note also the recovery data for Fe, As and Se all of which would ordinarily be biased because of the presence of interfering molecular species. A significant advance in SQ measurement accuracy in complex unknown matrices

**Table 2:** Semiquantitative analysis of NIST 1640 water using the 7500ce. Units ppb.

	FOUND	REFERENCE		FOUND	REFERENCE		FOUND	REFERENCE			
Li	7	Int Std	N/A	Se	78	21	21.96	Sm	147	0.072	N/A
Be	9	35	34.94	Br	79	<0.2	N/A	Eu	153	0.0098	N/A
B	10	280	301.1	Rb	85	2	2	Gd	157	0.65	N/A
Na	23	30,000	29350	Sr	88	120	124.2	Tb	159	0.0017	N/A
Mg	24	5700	5819	Y	89	0.051	N/A	Dy	163	0.021	N/A
Al	27	54	52	Zr	90	0.091	N/A	Ho	165	0.006	N/A
Si	28	4800	4730	Nb	93	0.0035	N/A	Er	166	0.016	N/A
P	31	35	N/A	Mo	95	46	46.75	Tm	169	<.0004	N/A
S	34	110	N/A	Ru	101	<0.003	N/A	Yb	172	0.0082	N/A
K	39	1000	994	Rh	103	Int Std	N/A	Lu	175	0.0007	N/A
Ca	44	9300	7045	Pd	105	<0.003	N/A	Hf	178	<0.0001	N/A
Sc	45	<0.006	N/A	Ag	107	7.7	7.62	Ta	181	0.0003	N/A
Ti	49	0.089	N/A	Cd	114	22	22.79	W	182	0.017	N/A
V	51	13	N/A	In	115	0.0046	N/A	Re	185	0.0067	N/A
Cr	52	37	12.99	Sn	118	2.1	N/A	Os	189	<0.002	N/A
Mn	55	120	121.5	Sb	121	15	13.79	Ir	193	Int Std	N/A
Fe	56	29	34.3	Te	125	<0.12	N/A	Pt	195	<0.001	N/A
Co	59	19	20.28	In	127	0.17	N/A	Au	197	0.0065	N/A
Ni	60	26	27.4	Cs	133	0.078	N/A	Hg	202	0.012	N/A
Cu	63	87	85.2	Ba	137	140	N/A	Tl	205	0.035	N/A
Zn	66	55	53.2	La	139	0.42	N/A	Pb	208	27	17.89
Ga	69	32	N/A	Ce	140	0.52	N/A	Bi	209	0.0015	N/A
Ge	72	Int Std	N/A	Pr	141	0.076	N/A	Th	232	0.16	N/A
As	75	24	26.67	Nd	146	0.35	N/A	U	238	0.85	N/A

was achieved with the development of the Agilent ORS. Operating in helium (He) mode the ORS removes all polyatomic interferences without the need to know sample content. Since He is an inert collision gas, no new interferences are created, which increases data integrity with unknown matrices. Thus the ORS can produce high quality SQ data from any unknown sample matrix, making it ideal for the screening analysis of large numbers of samples.

The other measurements typically carried out by ICP-MS are those that determine the relative abundances of two or more isotopes of the same element, known as **isotope ratio measurements**. Isotope ratio analysis is most commonly carried out on elements whose isotopic composition varies in nature [1]. The measurement of isotope ratios is also used as the calibration method for isotope dilution analysis, [2]. Isotope dilution depends on the accurate determination of isotope ratios in a sample after the addition of a purified spike of one of the isotopes of the analyte element(s). Since the alteration of the original isotope ratio is measured, rather than the response for the element, this method provides excellent precision and accuracy and is independent of recovery or other sample preparation effects.

Quadrupole ICP-MS (and single collector HR-ICP-MS) instruments have a single detector, which means that isotope ratio measurements must be made sequentially, which limits their precision. However, other commercial ICP-MS instruments known as multi-collector (MC) ICP-MS [3] have been developed with a detector array, whereby all of the isotopes of interest are measured simultaneously, using a separate detector for each measured mass. These instruments measure isotope ratios with a precision equivalent to Thermal Ionization Mass Spectrometry (TIMS) and routinely deliver about 10 times better isotope ratio precision than the best that can be achieved using a single collector instrument.

### References

1. Date, A. R. and Gray, A. L., 1983, *Int. J. Mass. Spectrom. Ion. Phys.*, 48, 357-360
2. Heumann, K. G., 1988, in *Inorganic Mass Spectrometry* (eds F. Adams, R. Gijbels and R. Van Grieken, Chemical Analysis Series, 95, Wiley, New York, 301-376
3. Walder, A. J., Koller, D., Reed, N. M., Hutton, R. C. and Freedman, P. A., 1993, *J. Anal. Atom. Spectrom.*, 8, 1037-1041



## Section 3 – Control of Interferences in ICP-MS



## Introduction

While quadrupole-based ICP-MS is an immensely powerful multi-element analytical technique, it does suffer from some well-documented spectral and non-spectral interferences. While many interferences can be corrected mathematically, provided the relative contribution of the interference to the analyte peak is not too great, most labs are switching to collision/reaction cell (CRC) instruments as they are much simpler to use, provide unequivocal results, can be applied to unrelated interferences on multiple analytes and provide better accuracy over a wide range of complex matrices.

The main sources of **spectral interferences** in ICP-MS are:

- Direct overlap from a different element with an isotope at the same nominal mass (isobars – see Figure 1) – known as an isobaric interference, e.g.  $^{114}\text{Sn}$  overlap on  $^{114}\text{Cd}$
- Overlap from a polyatomic ion formed from the combination of species derived from the plasma gas, sample solvent and/or sample matrix e.g.  $^{40}\text{Ca}^{16}\text{O}$  overlap on  $^{56}\text{Fe}$
- Doubly-charged species resulting from ions created by the loss of two electrons instead of just one. Because the quadrupole separates ions based on  $m/z$  (mass over charge ratio), a doubly-charged ion ( $M^{2+}$ ) will appear at mass  $M/2$ . An example of a doubly-charged interference would be the  $^{136}\text{Ba}^{2+}$  overlap on  $^{68}\text{Zn}^+$

There are many ways to remove or correct for spectral interferences. The easiest way to avoid a direct isobaric overlap is to choose another (interference free) isotope (Figure 1) of the element of interest, if available. For example,  $^{114}\text{Cd}$  is interfered with by the presence of  $^{114}\text{Sn}$ , so  $^{111}\text{Cd}$ , which has no isobaric overlap, can be used. The downside to this is that the detection limit may be degraded due to the low abundance of  $^{111}\text{Cd}$  (12.80%) whereas the  $^{114}\text{Cd}$  isotope is 28.73%. However, the interference has now been removed.

Oxides ( $\text{MO}^+$ ) and doubly charged species ( $M^{2+}$ ) can be significantly reduced through proper tuning of the plasma and torch conditions, and by good plasma design. Oxides are far more problematic in ICP-MS than doubly charged species, since there are very few elements that generate significant levels of doubly charged species, and these can be easily avoided. The most efficient ICP-MS plasma systems – broadly equating to those that create and maintain the highest effective plasma temperature – can decompose the sample matrix in the plasma more effectively and so  $\text{MO}^+$  levels are significantly lower than other systems. It has been demonstrated that  $\text{MO}^+$  level is directly proportional to other matrix-based interferences such as those derived from chloride and sulfate matrices. Thus a low level of  $\text{MO}^+$  (typically  $\text{CeO}/\text{Ce}$  is measured since the  $\text{CeO}$  bond is very strong and  $\text{CeO}$  is stable in the plasma) is a highly desirable property in an ICP-MS instrument. The  $\text{CeO}/\text{Ce}$  ratio is often referred to as a measure of plasma robustness in ICP-MS. A more robust plasma (lower  $\text{CeO}/\text{Ce}$ ) reduces the reliance on mathematical interference correction equations, and also makes interference removal techniques – such as CRCs – more efficient.

**Figure 1:** Conceptual differences in isotopes and isobars

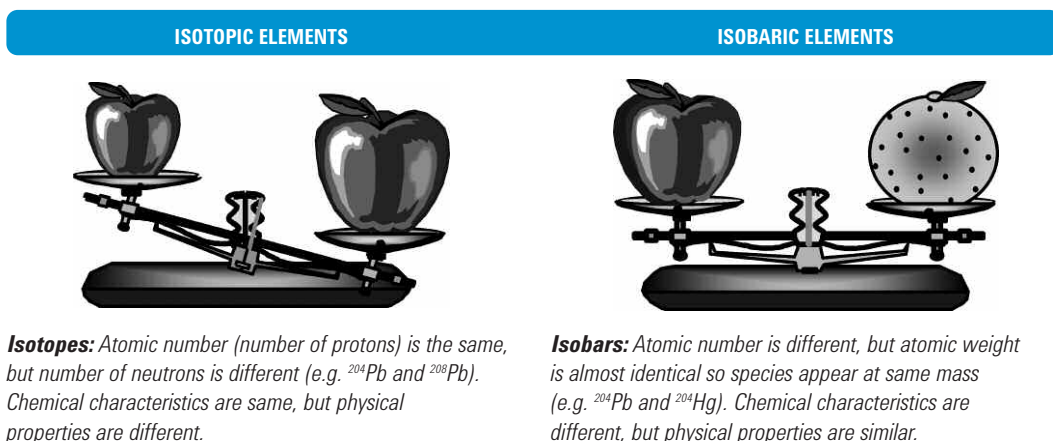

# Control of Interferences in ICP-MS

## Interference Equations

Interference equations are mathematical equations used to correct elemental, polyatomic and doubly charged isobaric interferences in ICP-MS analysis. They are based on the fact that the relative abundances of the naturally occurring isotopes of almost all elements are fixed in nature and are not changed through any sample preparation or analysis techniques.

Because natural isotopic abundances are known and constant, isobaric overlaps are predictable and, where an alternative, uninterfered isotope is either unavailable or too small in abundance, mathematical correction can be used to correct for isobaric spectral overlaps.

Although this type of correction can also be used for polyatomic interferences, the intensity of polyatomic species can vary with tuning, and many corrections need to go through more than one level of measurement and calculation to obtain a concentration value for the target element, leading to a level of uncertainty in the result. A common example is  $^{75}\text{As}$  as depicted in Figure 2. The interference correction equation routine works like so:

1. Acquire data at masses 75, 77, 82 and 83
2. Assume the signal at mass 83 is from  $^{83}\text{Kr}$  and use this to estimate the signal from  $^{82}\text{Kr}$
3. Subtract the estimated contribution from  $^{82}\text{Kr}$  from the signal at mass 82; the residual should be  $^{82}\text{Se}$
4. Use the estimated  $^{82}\text{Se}$  signal to predict the size of the signal from  $^{77}\text{Se}$  on mass 77.
5. Subtract the estimated  $^{77}\text{Se}$  contribution from the signal at mass 77; the residual should be from  $^{40}\text{Ar}^{37}\text{Cl}$
6. Use the calculated  $^{40}\text{Ar}^{37}\text{Cl}$  signal to estimate the contribution on mass 75 from  $^{40}\text{Ar}^{35}\text{Cl}$

7. Subtract the estimated contribution from  $^{40}\text{Ar}^{35}\text{Cl}$  on mass 75; the residual should be from  $^{75}\text{As}$

The most serious limitation of this type of correction equation is that it cannot deal with the common situation where another interference appears at one of the intermediate masses used in the calculation. In the As example provided, the presence of Br in the sample gives rise to a BrH interference at mass 82, which leads to an error in the calculated concentration of Se, which then propagates a further error in the calculated concentration of As. These errors can be very difficult to identify, since they can lead to either over- or under-reporting of the target analyte concentration. Another limitation of this approach arises if the intensity of the interference is very large compared to the analyte. The classic example is the interference of plasma-based interferences  $^{39}\text{Ar}^{\text{H}}$ ,  $^{40}\text{Ar}$  and  $^{40}\text{Ar}^{16}\text{O}$  on  $^{39}\text{K}$ ,  $^{40}\text{Ca}$  and  $^{56}\text{Fe}$  respectively. Although plasma-based interferences are relatively stable they are of very high intensity, and prevent the ultratrace determination of K, Ca and Fe which are essential analytes in the semiconductor industry. This led to the development of the cool plasma technique by Agilent in 1992, which in turn led to the rapid expansion of ICP-MS in the semiconductor industry.

## Cool Plasma Technique

The fundamental problem of these plasma-based interferences in high-purity semiconductor chemicals was largely overcome with the introduction of the Agilent ShieldTorch System in 1992. The ShieldTorch is illustrated schematically in Figure 3, which shows the position of a grounded shield plate between the ICP load coil and the plasma torch. The shield plate effectively removes the capacitive coupling of the coil to the plasma, thereby ensuring that the plasma is at ground potential. When combined with operation at low plasma power (600-900W), this eliminates the secondary discharge inside the interface

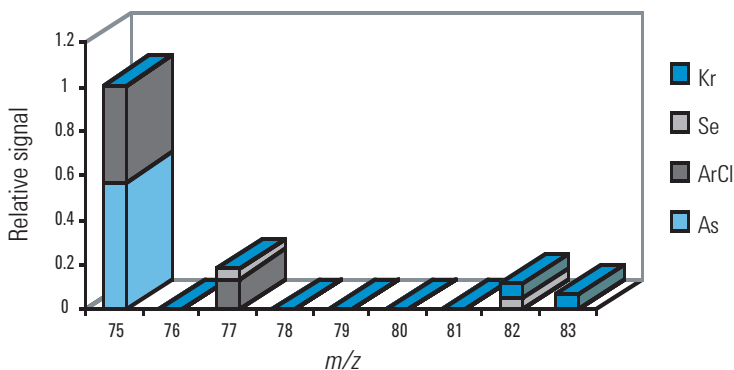

**Figure 2:** Example of spectrum showing complex correction for interference from ArCl on As (Intervening masses - 76, 78, 79, 80, 81 - not measured).



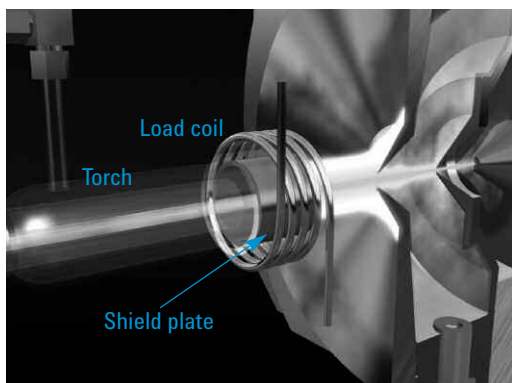

**Figure 3:** ShieldTorch System - Agilent 7500 Series

which is where the ionization of these plasma-based polyatomic species occurs. This resulting background spectrum is essentially free from plasma-based interferences.

The cool plasma technique was widely adopted in the semiconductor industry, where the accurate quantification of K, Ca and Fe at low ppt levels in high purity process chemicals is performed. In addition to removing Ar-based polyatomic ions from the mass spectrum, cool plasma conditions also effectively eliminate the background signal for easily ionized elements, such as Na and Li, improving detection limits for these metals. Cool plasma conditions do however introduce some disadvantages to general analysis, most particularly poorer matrix tolerance and less effective decomposition of  $MO^+$  species. As a result, the cool plasma technique is only applicable to samples containing either no matrix, or a very simple matrix. These limitations led to the development of collision and reaction cells.

### Collision Interface (T-mode)

This technique was developed and patented by Agilent in 1996 (Agilent T-mode system: US patent 6,262,717) to address the need to measure Fe in drinking water at the low ppb level. The design of the T-mode skimmer orifice promotes collisions between gas molecules and plasma based interferences like  $ArO^+$ , reducing some interferences by about 2 orders of magnitude. A collision gas can also be added to the cell, as described in the patent, but since there is no ion focusing in this region, interference removal is far less efficient than a collision cell, and only plasma-based interferences can be removed effectively.

### Collision/Reaction Cell (CRC) ICP-MS

The CRC devices in commercial ICP-MS instruments have been designed to remove polyatomic species, and were developed either through the need to find an alternative to cool plasma for the semiconductor industry or, in the case of Agilent, to extend the application of ICP-MS to the most complex and difficult sample types. Since the introduction of CRC ICP-MS in the late 1990's, the CRC configuration has become the standard in ICP-MS, such that the vast majority of all ICP-MS currently shipped are CRC systems.

Some CRC designs utilize very specific, single-element conditions to selectively and efficiently remove a single interfering species, using highly reactive gases and complex but theoretically predictable reaction pathways. Such instruments were developed as an alternative to cool plasma in the semiconductor industry, where the sample matrix is low, predictable and constant and the analyte concentrations are typically also very low. Other approaches use less reactive gases but more generic interference removal methods. The latter approach has proved suitable for the measurement of multiple analyte elements in complex and variable sample matrices, where the source and level of potential interferences cannot easily be predicted in advance. The Agilent Octopole Reaction System (ORS) was designed to operate effectively in either reaction or collision mode and, as such, is able to use both reactive and non-reactive gases. This means that the ORS is suitable both for interference removal in high-purity semiconductor reagents and for the removal of variable and unidentified interferences in complex matrices – a unique combination.

### Octopole Reaction System

The Agilent ORS is an octopole ion guide with excellent ion focusing and ion transmission properties. It is enclosed in a small internal volume cell that can be pressurized with a gas and is mounted on-axis to the quadrupole for high ion transmission, as shown in Figure 4. Cell gases helium and hydrogen are typically used and flow-rates into the cell are typically 4-6 mL/min. The interaction between the polyatomic ions and the cell gas leads to the removal of interference from the mass spectrum.

The ORS is typically operated in one of 3 different modes, which, due to the small cell volume and fast gas switching times, can be combined in a single acquisition.

- **No-gas mode** - no gas in the cell - the instrument performs like a standard ICP-MS. High sensitivity is achieved for all elements. This mode is typically used for uninterfered elements such as Be, Hg, Pb.

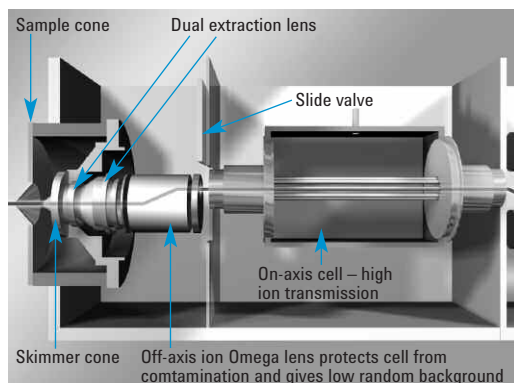

**Figure 4:** Schematic of Agilent ICP-MS showing the Octopole Reaction System (ORS) cell.

• **Helium (collision) mode** - used for all analytes that suffer matrix-based interferences ( $^{36}\text{Cl}^{16}\text{O}^+$  on  $^{51}\text{V}^+$ ,  $^{40}\text{Ar}^{12}\text{C}^+$  on  $^{52}\text{Cr}^+$ ,  $^{23}\text{Na}^{40}\text{Ar}^+$  on  $^{63}\text{Cu}^+$ ,  $^{40}\text{Ar}^{35}\text{Cl}^+$  on  $^{75}\text{As}^+$ ), and also reduces plasma-based interferences ( $^{40}\text{Ar}^{16}\text{O}^+$ ,  $^{40}\text{Ar}^{38}\text{Ar}^+$ ) to the ppt level. Interferences are removed based on their physical size, not on a specific reaction with a reaction gas. Since all polyatomic interferences are larger than the analytes they interfere with, they will collide with the He cell gas atoms more frequently than will the smaller analyte ions. The polyatomic ions will therefore lose more energy and will be prevented from entering the mass analyzer by a positive discrimination voltage: this process is termed kinetic energy bias (KED). The key to successful interference removal by KED is to control the ion energy spread of the ions that enter the cell – this is achieved by the ShieldTorch, originally developed for cool plasma, which restricts ion energy spread to less than 1 eV. A second, additional point is that since octopoles are smaller than the hexapoles or quadrupoles traditionally used in CRC ICP-MS, the ORS cell is very small, with small entrance and exit apertures, so cell pressure is high, promoting more collisions. The great benefit of He collision mode is that a single set of conditions removes all interferences, and since the cell gas is inert, no reaction with the sample matrix or analytes takes place and no new interferences are formed. Thus the user needs no prior knowledge of the sample matrix, and no specific setup for each analyte/interference is required – interference removal is non-specific.

• **Hydrogen (reaction) mode** - used only for the very few situations where He collision mode is not efficient enough, which is only for intense plasma-based interferences and where the analyte interfered by a plasma-based interference needs to be quantified at the low ppt level. For example  $^{38}\text{Ar}^+\text{H}$ ,  $^{40}\text{Ar}$  and  $^{40}\text{Ar}^{16}\text{O}$  on  $^{39}\text{K}$ ,  $^{40}\text{Ca}$  and  $^{56}\text{Fe}$  in semiconductor analysis. Of course cool plasma can still be used if preferred. The other main application is ultratrace Se measurement (He collision mode is limited to about  $<0.1\text{ ng/mL Se DL}$ ). In  $\text{H}_2$  reaction mode, interferences are “reacted” away by protonation or charge transfer before entering the mass filter region. An example of this would be as follows:  
 $\text{Ar}^+ + \text{H}_2 \rightarrow \text{Ar} + \text{H}_2^+$   
 In this example the ionized Argon is neutralized by  $\text{H}_2$ , which then allows for the measurement of Ca at its primary (96.94% abundance) isotope at mass 40. Reaction mode has the highest interference removal efficiency for the most intense plasma-based interferences. The drawback of reaction mode is that it can form new interferences (for example  $\text{MH}^+$  in the case of hydrogen-containing reaction gases -  $\text{H}_2$ ,  $\text{NH}_3$ ,  $\text{CH}_4$ , etc), and also react with some analytes. When reactive gases are used with the Agilent ORS, any new, cell-formed polyatomic ions that are created have inherently low ion energy and are therefore rejected by the KED bias voltage. However, the limitations of highly reactive cell gases mean that they are not suitable for multi-element analysis in complex or variable sample matrices.

### Helium Collision Mode

As stated above, the Agilent ORS technology can apply controlled KED in helium collision mode to eliminate polyatomic interferences [1,2]. This provides ORS instruments with the ability to remove interferences without prior knowledge of the matrix. In addition, using KED to remove interferences permits measurement of all elements under a single set of conditions.

### Why Isn't He Collision Mode Universal?

Not all ICP-MS manufacturers use a physically grounded plasma (like the Agilent ShieldTorch, Figure 1) on their instruments. As a result, the energy spread of the ions entering the cell is much wider and KED can not effectively separate interference and analyte based on their differential energy loss due to collision. As a result reaction mode is the only possible method of operation. Instruments with a physically grounded plasma can make use of KED, but design differences in the ion optics and CRC compared to the Agilent system may make the KED much less efficient.

## Practical Test of He Collision Mode

The effectiveness of He collision mode to remove multiple polyatomic interferences in complex matrices can be tested. The proposed test is that multiple, unidentified and compound polyatomic interferences (i.e. more than one interference at each analyte mass) could be removed under a single set of He mode cell conditions. In evaluating the degree of removal of such interferences, the signal intensities for the background peaks both with and without He cell gas are compared, to illustrate which background peaks might pose a problem for non-cell conditions (standard mode, cell not pressurized) and which of these peaks could be attenuated to close to background levels (allowing for trace contamination in the mixed components of the high matrix sample) under a single set of He cell gas conditions.

To simulate the range of potential polyatomic interferences (summarized in Table 1) that might be derived from a realistic complex sample matrix, a mixed synthetic sample matrix was prepared, combining 1% HNO<sub>3</sub>, 1% HCl and 1% H<sub>2</sub>SO<sub>4</sub> (all UpA UltraPure Reagents, Romil, Cambridge, UK), 1% Butan-1-ol (SpS Super Purity, Romil, Cambridge, UK) and 100 mg/L (ppm) each of Na and Ca (both prepared from 10,000 mg/L Spex CertiPrep Assurance single element standards). All solutions were prepared by dilution using de-ionized water. All sample matrix components were mixed in a single solution, which was then analyzed using the 7500ce ICP-MS, with an acquisition method that switched automatically between He mode and standard mode. In each of these two modes, all

of the analytes were measured using identical instrumental and acquisition conditions, and no data correction was applied (no background subtraction, no interference correction, etc). This represents the situation which exists in a typical routine laboratory, where the sample composition is not known in advance and therefore suitable matrix blanks may not be available and custom correction equations may not be applicable in a given sample matrix.

## Comparison of Background Spectra

The background spectrum obtained in no-gas mode is shown in Figure 5a, together with the same spectrum (same mass range and intensity scale) under He cell mode conditions, in Figure 5b.

The combination of normal plasma backgrounds (due to the argon and components of the aqueous sample solution (Ar, O, H)), together with the additional components of the matrix sample (containing 1% each of HNO<sub>3</sub>, HCl, H<sub>2</sub>SO<sub>4</sub>, butanol, and 100 ppm each of calcium and sodium), leads to the formation of several high intensity background peaks in the normal ICP-MS spectrum (see Figure 5a), notably <sup>56</sup>Ar<sup>16</sup>O<sup>+</sup> and <sup>80</sup>Ar<sup>2+</sup> from the plasma, but also <sup>40</sup>Ar<sup>12</sup>C<sup>+</sup>, <sup>32</sup>S<sup>2+</sup>, <sup>40</sup>Ca<sup>16</sup>O<sup>1</sup>H<sup>+</sup>, etc, from the matrix. These high intensity background peaks are a graphic illustration of the reason why several interfered elements (<sup>56</sup>Fe, <sup>76</sup>Se and <sup>80</sup>Se, <sup>52</sup>Cr in a carbon matrix, <sup>65</sup>Zn in a sulfur matrix) have traditionally been considered as difficult elements for ICP-MS. Under He mode conditions (see Figure 5b), all of these high intensity background peaks are removed from the spectrum,

**Table 1:** Principal polyatomic interferences from an aqueous matrix containing N, S, Cl, C, Na & Ca

ISOTOPE	PRINCIPAL INTERFERING SPECIES (Ca, Na, N, S, Cl, C MATRIX)	ISOTOPE	PRINCIPAL INTERFERING SPECIES (Ca, Na, N, S, Cl, C MATRIX)
<sup>51</sup> V	<sup>35</sup> Cl <sup>16</sup> O, <sup>37</sup> Cl <sup>14</sup> N	<sup>66</sup> Zn	<sup>34</sup> S <sup>16</sup> O <sub>2</sub> , <sup>32</sup> S <sup>34</sup> S, <sup>33</sup> S <sub>2</sub> , <sup>48</sup> Ca <sup>18</sup> O
<sup>52</sup> Cr	<sup>36</sup> Ar <sup>16</sup> O, <sup>40</sup> Ar <sup>12</sup> C, <sup>35</sup> Cl <sup>16</sup> OH, <sup>37</sup> Cl <sup>14</sup> NH	<sup>67</sup> Zn	<sup>32</sup> S <sup>34</sup> SH, <sup>33</sup> S <sub>2</sub> H, <sup>48</sup> Ca <sup>18</sup> OH, <sup>14</sup> N <sup>16</sup> O <sup>37</sup> Cl, <sup>16</sup> O <sub>2</sub> <sup>35</sup> Cl
<sup>53</sup> Cr	<sup>36</sup> Ar <sup>16</sup> OH, <sup>40</sup> Ar <sup>13</sup> C, <sup>37</sup> Cl <sup>16</sup> O, <sup>35</sup> Cl <sup>18</sup> O, <sup>40</sup> Ar <sup>12</sup> CH	<sup>68</sup> Zn	<sup>32</sup> S <sup>18</sup> O <sub>2</sub> , <sup>34</sup> S <sub>2</sub>
<sup>54</sup> Fe	<sup>40</sup> Ar <sup>14</sup> N, <sup>40</sup> Ca <sup>14</sup> N	<sup>69</sup> Ga	<sup>32</sup> S <sup>18</sup> O <sub>2</sub> H, <sup>34</sup> S <sub>2</sub> H, <sup>16</sup> O <sub>2</sub> <sup>37</sup> Cl
<sup>55</sup> Mn	<sup>37</sup> Cl <sup>18</sup> O, <sup>23</sup> Na <sup>32</sup> S,	<sup>70</sup> Zn	<sup>34</sup> S <sup>18</sup> O <sub>2</sub> , <sup>35</sup> Cl <sub>2</sub>
<sup>56</sup> Fe	<sup>40</sup> Ar <sup>16</sup> O, <sup>40</sup> Ca <sup>16</sup> O	<sup>71</sup> Ga	<sup>34</sup> S <sup>18</sup> O <sub>2</sub> H
<sup>57</sup> Fe	<sup>40</sup> Ar <sup>16</sup> OH, <sup>40</sup> Ca <sup>17</sup> OH	<sup>72</sup> Ge	<sup>40</sup> Ar <sup>32</sup> S, <sup>35</sup> Cl <sup>37</sup> Cl, <sup>40</sup> Ar <sup>16</sup> O <sub>2</sub>
<sup>58</sup> Ni	<sup>40</sup> Ar <sup>18</sup> O, <sup>40</sup> Ca <sup>18</sup> O, <sup>23</sup> Na <sup>35</sup> Cl	<sup>73</sup> Ge	<sup>40</sup> Ar <sup>33</sup> S, <sup>35</sup> Cl <sup>37</sup> ClH, <sup>40</sup> Ar <sup>16</sup> O <sub>2</sub> H
<sup>59</sup> Co	<sup>40</sup> Ar <sup>18</sup> OH, <sup>43</sup> Ca <sup>16</sup> O	<sup>74</sup> Ge	<sup>40</sup> Ar <sup>34</sup> S, <sup>37</sup> Cl <sub>2</sub>
<sup>60</sup> Ni	<sup>44</sup> Ca <sup>16</sup> O, <sup>23</sup> Na <sup>37</sup> Cl	<sup>75</sup> As	<sup>40</sup> Ar <sup>34</sup> SH, <sup>40</sup> Ar <sup>35</sup> Cl, <sup>40</sup> Ca <sup>35</sup> Cl
<sup>61</sup> Ni	<sup>44</sup> Ca <sup>16</sup> OH, <sup>38</sup> Ar <sup>23</sup> Na, <sup>23</sup> Na <sup>37</sup> ClH	<sup>77</sup> Se	<sup>40</sup> Ar <sup>37</sup> Cl, <sup>40</sup> Ca <sup>37</sup> Cl
<sup>63</sup> Cu	<sup>40</sup> Ar <sup>23</sup> Na, <sup>12</sup> C <sup>16</sup> O <sup>35</sup> Cl, <sup>12</sup> C <sup>14</sup> N <sup>37</sup> Cl	<sup>78</sup> Se	<sup>40</sup> Ar <sup>38</sup> Ar
<sup>64</sup> Zn	<sup>32</sup> S <sup>16</sup> O <sub>2</sub> , <sup>32</sup> S <sub>2</sub> , <sup>36</sup> Ar <sup>12</sup> C <sup>16</sup> O, <sup>38</sup> Ar <sup>12</sup> C <sup>14</sup> N, <sup>48</sup> Ca <sup>16</sup> O	<sup>80</sup> Se	<sup>40</sup> Ar <sub>2</sub> , <sup>40</sup> Ca <sub>2</sub> , <sup>40</sup> Ar <sup>40</sup> Ca, <sup>40</sup> Ar
<sup>65</sup> Cu	<sup>32</sup> S <sup>16</sup> O <sub>2</sub> H, <sup>32</sup> S <sub>2</sub> H, <sup>14</sup> N <sup>16</sup> O <sup>35</sup> Cl, <sup>48</sup> Ca <sup>16</sup> OH		

## Control of Interferences in ICP-MS

indicating both the effectiveness and the universal applicability of a completely inert cell gas combined with efficient energy discrimination.

If the vertical scale is expanded 100x as shown in Figure 6a, many more, lower intensity matrix-derived polyatomic species can also be identified. Many of these species, though present at lower levels than the normal, plasma-derived background polyatomic ions, have the potential to cause errors in routine sample analysis. Their presence and intensity is dependent on the matrix composition, which, in routine laboratories, is not typically constant or known.

As with the comparison shown in Figures 5a and 5b, this expanded scale spectrum is also compared with the same sample measured using He cell gas (shown in Figure 6b). Even at this expanded scale, it is clear that the use of He cell gas mode has reduced the background species to

very low levels, including the high intensity plasma-based species  $\text{ArO}^+$  and  $\text{Ar}_2^+$ . The only peaks clearly visible in He mode on this scale are traces of Fe and Zn (the peak template confirms the Zn isotopic pattern at  $m/z$  64, 66 and 68), probably derived from trace level contamination of one of the matrix components. By contrast, in no cell gas mode (Figure 6a), almost every isotope of every element in this mass region has an overlap from at least one matrix-derived polyatomic interference.

Clearly the presence of these interferences makes reliable measurements of many trace elements very difficult. The situation is even more complicated under conditions where the matrix composition, and so the level of the interference, changes from one sample to another. It is for this reason that many workers have had to rely on empirically derived and maintained interference correction equations, [3] which may introduce errors if an unexpected matrix component occurs on one of the intermediate masses used in the correction. Furthermore, in

routine laboratories, it is typically not possible to spend a large amount of time characterizing and updating the required corrections for the large and variable set of potential matrix interferences.

### Measurement of Analytes in the Presence of the Sample Matrix

Having demonstrated the effective reduction of the wide range of plasma-based and matrix-based polyatomic ions, under a single set of He mode cell conditions (Figures 5 and 6), a second sample was analyzed, consisting of the same multi-component matrix, but spiked with a multi-element standard, to check that the

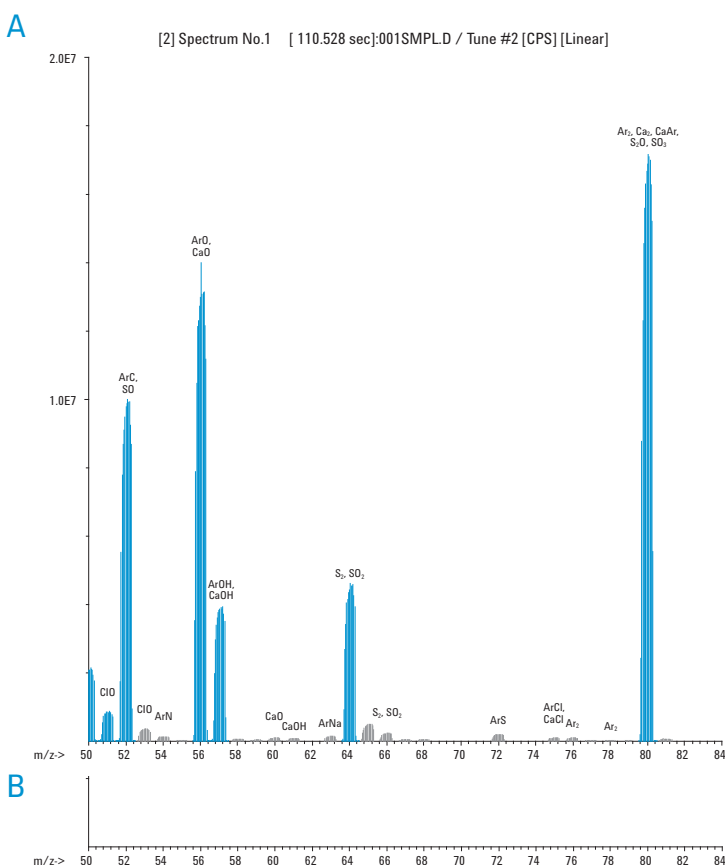

**Figure 5:** High intensity interfering polyatomic ions from high matrix sample (see text for composition) in no cell gas (a) and He cell gas (b) modes, on same intensity scale (2.0E7)

same cell conditions used for interference removal, also gave sufficient analyte sensitivity to permit the analysis of the trace elements in this mass range. The spike consisted of 5 ng/mL (ppb) each of V, Cr, Mn, Fe, Co, Ni, Cu, Zn, Ge, As and Se. All of these elements had at least one analytically useful isotope with a polyatomic overlap in no cell gas mode in this matrix.

In addition to providing information on the available signal for these trace elements following removal of the plasma- and matrix-derived interferences, this spiked sample analysis illustrates that the presence of other analyte ions did not lead to any new, cell-formed polyatomic ions and that multiple analyte ions could be measured under a single set of He mode conditions. Both of these capabilities are unique to inert cell gases, as all reactive cell gases will react with some analytes, as well as with some interferences. Analyte ion signal loss by reaction and the production of new polyatomic and cluster ions are inevitable consequences of the use of a reactive gas in the collision/reaction cell.

Using an inert cell gas ensures that unexpected or variable analyte concentrations or matrix levels do not lead to new interfering species. Pressurizing the cell causes some loss of signal due to ion scattering; however analyte signal is maintained with acceptable consistency for all analytes allowing multi-element analysis under a single set of conditions.

**Figure 6:** Low intensity interfering polyatomic ions from high matrix sample in no cell gas (a) and He cell gas (b) modes, at 100x lower intensity scale (2.0E5) than shown in Figure 5

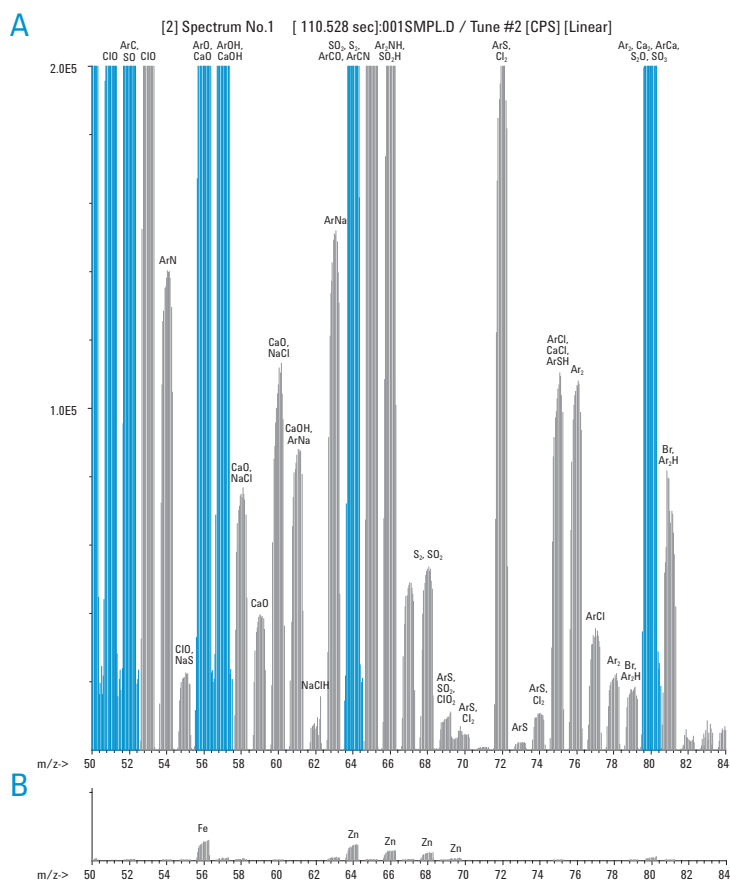

The comparison of the spectra obtained in He mode for the blank (unspiked) matrix and the spiked matrix (all analytes at 5 ng/mL) is shown in Figures 7a and 7b. Note that these spectra are shown on an intensity scale that is a further 40x lower than that used for Figures 6a and 6b, allowing the presence of the contaminant elements (Fe, Ni, Cu, Zn) to be confirmed from their isotopic templates.

The spectra shown in Figures 7a and 7b illustrate the capability of the He cell gas mode to give access to multiple isotopes for each analyte, with the theoretical isotopic pattern templates matching the measured mass spectrum for every element. No significant residual interferences were observed, with the exception of the  $ArOH^+$  and  $Ar_2^+$  peaks, the peak at mass 80 being equivalent to about 5 ng/mL Se. However, the polyatomic interferences on the other Se isotopes at  $m/z$  77, 78 and 82 were removed effectively, allowing Se determination

# Control of Interferences in ICP-MS

at any of these isotopes ( $^{76}\text{Se}$  would also be available, but is overlapped by  $^{76}\text{Ge}$  in this standard). If low level Se ( $<0.1\text{ ng/mL}$ ) analysis is required, then the normal multi-mode operation may be utilized, with  $\text{H}_2$  reaction mode being used for those specific analytes with known and consistent interferences (such as  $^{80}\text{Se}$ ), and He mode being used for those analytes with variable, unknown or multiple polyatomic interferences.

## Interference Removal by Reaction Mode – Considerations

Reaction cell instruments without sufficient ion energy control to provide highly efficient energy discrimination can only be operated in reaction mode. A reactive gas e.g.  $\text{H}_2$ ,  $\text{CH}_4$ ,  $\text{NH}_3$ , etc. is added to the cell to react with the interference, either converting it to a different species or neutralizing it (converting it to an un-charged atom or molecule).

However, reaction mode can suffer from several limitations:

- 1) To select the appropriate reaction gas to separate a given analyte and interferant pair, the reactivity of both must be known; in other words, the interferant and therefore the matrix composition must be known before the sample is analyzed. In some cases, this is possible, since the interferant may be an easily identified background peak, which is constant in all matrices, or there may be only one possible polyatomic ion at the analyte mass. In complex, real world samples however, this is not the case and an unexpected new interference may be completely unreactive with the chosen reaction gas, or may react to form a new interference elsewhere in the mass spectrum.
- 2) The reaction gas must react quickly with the interferant and slowly, or not at all, with the analyte. This is also possible in some cases, and is a particular strength of hydrogen as a reaction gas, which is why  $\text{H}_2$  is used as a reaction gas for several argon-based polyatomic ions ( $\text{ArO}$ ,  $\text{Ar}_2$ ). However,  $\text{H}_2$  does not react quickly with many matrix-based polyatomic ions ( $\text{ClO}^+$ ,  $\text{SO}_2^+$ ) and so  $\text{H}_2$  is not suitable for large numbers of interfered elements. More reactive gases, such as  $\text{CH}_4$  and  $\text{NH}_3$ , react quickly with a larger number of matrix-based polyatomic ions, but also react with many analytes, making them unsuitable for multi-element analysis.

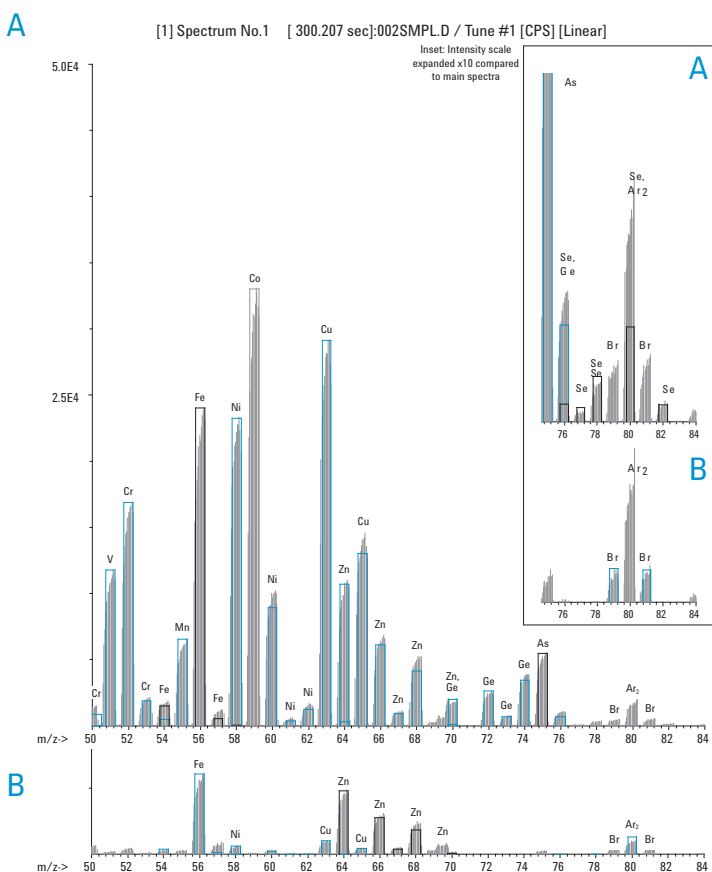

**Figure 7:** High matrix sample in He mode, unspiked (b) and spiked at 5ppb for V, Cr, Fe, Mn, Ni, Co, Cu, Zn, Ge, As and Se (a). Intensity scale of 5.0E4 (5.0E3 for inset spectra)

3) The reaction gas should not react with analyte ions or matrix ions to give new polyatomic ions, which could lead to new interferences. This is a particular limitation of highly reactive gases like CH<sub>4</sub> and NH<sub>3</sub> – they cause sequential secondary reactions, producing a large number of new cluster ions. To overcome this limitation and permit the use of these reactive gases, one commercial cell configuration, known as a Dynamic Reaction Cell (DRC) [4], uses a quadrupole as the cell ion guide, which allows the stability regions within the cell to be controlled in such a way as to reject ions a set mass below and above the target analyte mass. This is known as a "band-pass" filter and its function is to stop the newly formed cluster ions from appearing in the mass spectrum and causing new interference overlaps.

It should be noted that the use of a band-pass filter to reject newly formed and potentially interfering polyatomic or cluster ions does not stop the formation of such ions. This means that the reported high reaction rate of analytes (such as As<sup>+</sup> and Ni<sup>2+</sup>) with highly reactive gases (such as NH<sub>3</sub>) does, in practice, lead to analyte loss.

## Summary

Recent advances in collision/reaction cell (CRC) technology have led to dramatic improvements in the analysis of certain interfered trace elements which previously proved difficult to measure at the required levels in certain sample matrices. However, in practice, users of some designs of "reaction mode only" CRCs limit the system to the removal of single interfering ions from single analytes, e.g. [5-12] where specific measurement conditions need to be used. In these cases, the CRC-ICP-MS are only appropriate for single analyte/ interference pairs in stable, consistent, known sample matrices. In contrast, the Agilent ORS utilizes He collision mode for interference removal, enabling the use of

a single set of operating conditions for the analysis of all analytes, both interfered and uninterfered, in all sample matrices. This better reflects the analytical requirements of a routine contract analysis laboratory, where the composition of the samples is typically unknown, time is not available for specific method development for each sample or each analyte, and consistent instrument conditions are used routinely for all sample types.

## References

- 1 M. A. Dexter, H. J. Reid and B. L. Sharp, 2002, *J. Anal. Atom. Spectrom.*, **17**, 676
- 2 N. Yamada, J. Takahashi and K. Sakata, 2002, *J. Anal. Atom. Spectrom.*, **17**, 1213
- 3 J. L. M. de Boer, 2000, *J. Anal. Atom. Spectrom.*, **15**, 1157
- 4 V. I. Baranov and S. D. Tanner, *J. Anal. At. Spectrom.*, 1999, **14**, 1133.
- 5 G. K. Koyanagi, V. I. Baranov, S. D. Tanner and D. K. Bohme, 2000, *J. Anal. Atom. Spectrom.*, **15**, 1207
- 6 P. R. D. Mason, K. Kaspers and M. J. van Bergen, 1999, *J. Anal. Atom. Spectrom.*, **14**, 1067
- 7 J. M. Marchante Gayon, I. Feldmann, C. Thomas and N. Jakubowski, 2000, *J. Anal. Atom. Spectrom.*, **16**, 457
- 8 E. H. Larsen, J. Sloth, M. Hansen and S. Moesgaard, 2003, *J. Anal. Atom. Spectrom.*, **18**, 310
- 9 H-T. Liu and S-J. Jiang, 2003, *Anal. Bioanal. Chem.*, **375**, 306
- 10 D. R. Bandura, S. D. Tanner, V. I. Baranov, G. K. Koyanagi, V. V. Lavrov and D. K. Bohme, in *Plasma Source Mass Spectrometry: The New Millennium*, eds. G. Holland and S. D. Tanner, The Royal Society of Chemistry, Cambridge, 2001, p. 130
- 11 C. C. Chery, K. DeCremer, R. Cornelis, F. Vanhaecke and L. Moens, 2003, *J. Anal. Atom. Spectrom.*, **18**, 1113
- 12 F. Vanhaecke, L. Balcaen, I. Deconinck, I. De Schrijver, C. M. Almeida and L. Moens, 2003, *J. Anal. Atom. Spectrom.*, **18**, 1060



## Section 4 – Sample Preparation and Contamination Control





## Sample Preparation

Sample preparation requirements for analysis by ICP-MS are generally simpler than other trace element techniques. In most cases, close matrix matching of the calibration standards to the sample is not required, and the wide linear dynamic range of ICP-MS means that fewer calibration points are required and multiple dilutions of a single sample are not necessary. The most important consideration is to ensure the Total Dissolved Solids (TDS) level is appropriate for ICP-MS – the generally accepted upper limit is 2000 ppm TDS, though this can vary depending on matrix type. Normally a simple dilution with 1% nitric acid is used to bring the TDS level into range. For the digestion of solids, matrix interferences arising from chloride, sulfur, phosphorus and organic material in ICP-MS has meant that analysts have been limited to nitric acid or nitric/hydrofluoric acid digestion solutions. In the case of samples such as seawater and most groundwaters and wastewaters, the chloride content has made the determination of arsenic and vanadium difficult or impossible by ICP-MS, due to interference by chloride-based polyatomic species. More recently, however, with the advent of collision/reaction cell (CRC) ICP-MS, especially He collision mode, which effectively eliminates all matrix-based polyatomic interferences, the analyst has much more freedom in the choice of solvents and acids for digestion. An aqua regia digestion matrix can now be used, and stabilization with hydrochloric acid (of both standards and samples) can also be used without fear of generating interferences. This is a major advantage of He collision mode, which is changing established sample preparation methodology in ICP-MS, simplifying sample stabilization, preparation and analysis. The capability of He collision mode to measure trace As, Se, V, Fe and other interfered analytes in complex matrices is also enabling ICP-MS instruments like the Agilent 7500ce to replace GFAAS instrumentation in foods, clinical and other labs, which had previously retained at least one GFAAS instrument for these traditionally difficult ICP-MS analytes.

Below are some general considerations for ICP-MS sample preparation:

- ICP-MS measurement is only as good as the quality of reagents used, and the additional sensitivity of ICP-MS over other metals techniques such as ICP-OES means that reagents used for ICP-OES analysis may not be acceptable for ICP-MS, depending on the reporting limits required for the common contaminant elements. See “Contamination Control” in this section for more details.
- Total dissolved Solids (TDS) level – dilute the sample to 2000 ppm maximum TDS for routine analysis. This can be higher for certain matrices such as brine where 2-3% can be analyzed routinely.
- Filtration or centrifugation can be used for samples containing particulates which might clog sample line tubing and the nebulizer. However, since analytes may be contained in or adsorbed to the particulate fraction, it is important to be aware that filtered or centrifuged samples will not contain results for total metals, only soluble metals. The filtration apparatus may also cause a loss of analytes through adsorption to the filter or housing and may introduce contamination.
- Wet chemical digestion.
  - Open vessel digestion requires an acid or a mixture of acids acting on a sample in a heated open container and is the most commonly used digestion technique. However care must be taken to avoid contamination from airborne particulates, and cross contamination from sample to sample through spattering. A further consideration is the potential for loss of volatile analytes from open acid digestions, particularly if the sample is allowed to go dry during the digestion.
  - Closed vessel digestion has advantages over the former technique. A closed vessel digestion increases the pressure and effective temperature of the digestion solution and hence increases the digestion efficiency, as well as ensuring that volatile elements are not lost to the atmosphere.
  - Microwave digestion is an efficient and quick technique for many types of solid samples, such as plant materials, foods, etc.
- Alkali fusion can be used for the digestion of generally insoluble geological and metallurgical samples, using reagents such as lithium metaborate ( $\text{LiBO}_2$ ), lithium tetraborate ( $\text{Li}_2\text{B}_4\text{O}_7$ ), sodium hydroxide ( $\text{NaOH}$ ) and sodium peroxide ( $\text{Na}_2\text{O}_2$ ). These fusion techniques are very useful in the dissolution of various types of geological and metallurgical samples. However, compared to wet chemical digestion, the alkali fusion technique introduces extra dissolved solids as well as impurities into the sample solution resulting in matrix effects and contamination.

# Sample Preparation and Contamination Control

## Regulatory Requirements for Sample Preparation

Regulatory requirements outline in detail recommended sample preparation steps for sample analysis by ICP-MS. For example the USEPA document SW-846 *“Test Methods for Evaluating Solid Waste, Physical/Chemical Methods”* provides procedures for the determination of dissolved elements in various waste samples. Nine different sample preparation methods for inorganics are specified, depending on the analyte of interest and the sample type. Seven of these (methods 3005, 3010, 3015, 3020, 3050, 3051 and 3052) are applicable to ICP-MS analysis. SW-846 can be found online at: <http://www.epa.gov/epaoswer/hazwaste/test/sw846.htm>

## Contamination Control

### ICP-MS, Clean Chemistry and Detection Limits

Two important performance criteria used in assessing signal to noise are Instrument Detection Limits (IDL) and Background Equivalent Concentration (BEC) .

IDL is defined as the concentration that is equivalent to 3 times the variation of the background signal and is also known as the "3 sigma detection limit". These limits can be calculated by :

1. Analyzing a blank solution for all target elements at least 10 times
2. Analyze a standard with the target element(s) at known concentrations
3. The IDL is  $(3 \times \text{standard deviation of the blank}) / (\text{signal from the standard} - \text{signal for the blank})$  expressed relative to the concentration of the standard used (e.g. multiply by 1000 to give the IDL in ppt when using a 1 ppb standard).

The Background Equivalent Concentration (BEC) is simply the magnitude of a signal in a blank, expressed as a concentration. This can be calculated by:

1. Analyzing a blank solution for all target elements at least 10 times
2. Analyze a standard with the target element(s) at known concentrations

3. The BEC is  $\text{signal from the blank} / (\text{signal from the standard} - \text{signal for the blank})$ , again, expressed relative to the concentration in the standard.

While modern ICP-MS instruments are fully capable of IDL and BEC in the ppt or even sub ppt range, most laboratories never achieve those limits under routine conditions. There are a number of reasons for this, though fortunately, most routine analytical work does not require sub ppt limits of quantification. The biggest single reason for practical quantification limits (PQLs) being higher than instrument detection limits (IDLs) is related to the analytical blank. The analytical blank is a measure of all external sources of elemental contamination and is used to correct the measured sample concentration. The relative contribution of the blank signal to the sample concentration result may be of little consequence at the high analyte concentrations typically measured for many of the major and minor constituents.

However, in the case of elements determined at trace levels, as applies to many of the elements routinely measured by ICP-MS, the blank may contribute a large proportion of the analyte signal. In these cases, the quality (or uncertainty) of the reported result will be adversely affected by a high and variable blank level.

Therefore, in order to improve the accuracy and precision of trace metal determinations, steps must be taken to control the analytical blank. For the most part, this involves limiting exposure of the sample to all sources of outside contamination. These sources include:

- Airborne contamination
- Contaminated acids and reagents
- Contaminated glassware and plastic ware
- Personal contamination

Depending on the laboratory environment, any or all of the above sources may play a major role in contaminating the samples and blanks, and steps must be taken to reduce them all.

**Airborne contamination** is the result of the sample being exposed to unfiltered air during sampling, handling or preparation. A major source is corrosion from the digestion hood during open vessel digestions. Additional sources can come from other sources of laboratory dust, including ceiling tiles, flaking paint, carpeting or dirt tracked in on shoes. It may also be introduced from outdoor sources or corroded ducting via the ventilation and air conditioning

systems. Airborne contamination can be avoided by minimizing or eliminating exposure of the sample to unfiltered air through the use of:

- Closed vessel digestions
- HEPA filtered air in hoods
- Covered autosamplers with HEPA filtered air
- Clean rooms

**Contaminated acids and reagents** are also a significant source of metals contamination. ICP-MS is capable of extremely low detection limits for most elements, but the requirement for high purity reagents is determined by the required reporting limits of any given application, rather than the measurement capability of the instrument. Generally, for trace level work, ASTM Type 1 water is required. This water is characterized by  $18\text{M}\Omega\text{ cm}^{-1}$  resistivity or very low levels of trace metal ions. Acids used in dilution or digestion must be sufficiently low in target trace metals as to not adversely affect the blank concentration. Generally this means at least trace metal grade acids, but frequently means semiconductor grade. Semiconductor grade acids are purified through sub-boiling distillation. They can be purchased or prepared in the laboratory. Of course, high purity acids must be stored and handled carefully in order to maintain their purity. For this reason, it is advisable to store all high purity reagents in small volumes in sealed high purity, normally fluorocarbon, containers.

**Contaminated glassware and plastic ware** is another common source of high laboratory blanks. This would commonly include vessels containing the samples during sampling, storage and sample preparation, as well as containers for acids and reagents used in sample preparation. It also includes such things as pipettes, or pipette tips, gloves, measuring devices such as beakers, spatulas etc. Also included in this category are such common laboratory supplies as wipes and plastic films that may come in contact with the sample or sample containers. In general it is best to avoid contact between the sample and anything that is not pre-cleaned (and tested), or certified to be free from trace metal contamination.

When choosing sample containers, the material the container is made from is important. Borosilicate glass is inexpensive but contains relatively high levels of many trace metals. Quartz is much cleaner, with Type III being cleaner than Type II, which is cleaner than Type I [1]. Synthetic polymers (plastics) also vary widely in their suitability for trace metal work, by virtue of their resistance to temperature and acids or bases and trace metal content. The commonly used materials are

polyethylene (high and low density), polypropylene, and various fluoropolymers (Teflon). Low density polyethylene is lower in trace metals than high density polyethylene which uses metal catalysis in its manufacture. Polypropylene has similar levels of metal contaminants to polyethylene, but is more rigid and stable at temperatures up to about  $135^{\circ}\text{C}$ . For this reason, it is commonly used in open vessel digestion containers. Fluorocarbons generally exhibit the highest chemical inertness and lowest levels of trace metals. They are however expensive. There are three common fluoropolymers used in trace metal analysis, PTFE, PFA and FEP [1].

**Personal contamination** is contamination introduced to the sample by exposure to the analyst. It can be in the form of fingerprints, which naturally contain high levels of many metals [1]. This can be exacerbated by the use of various lotions and cosmetics. Jewelry can also contribute to trace metal background. Airborne contamination originating with the analyst is also important. This may include dust or lint from clothing, scalp or hair, or aerosols generated from coughs or sneezes. Many shampoos contain selenium or lead. Skin creams contain aluminum, titanium, zinc, magnesium and many trace components. Lipstick, mascara, blush, eye shadow, and face powder contain a periodic table of major and trace metals. For these reasons, it is always advisable to wear a clean, lint-free laboratory coat or smock and metal free gloves when handling samples. Shoe covers, bonnets, facemasks and full body suits may be necessary for ultra trace level work.

## References

1. Clean Chemistry Techniques for the Modern Laboratory, Dr. Robert Richter, Milestone Inc.  
[www.milestonesci.com](http://www.milestonesci.com)

## For More Information

See Contamination Control pages and Semiconductor Laboratory Startup & Contamination Control Guide on the Agilent web site at: [www.agilent.com/chem/icpms](http://www.agilent.com/chem/icpms)



## Section 5 – Extending the Capabilities of ICP-MS



The range of applications that can be addressed by ICP-MS instruments can be extended considerably using optional sample introduction accessories. ICP-MS manufacturers and third party specialty companies offer a range of optional accessories, which enhance the functionality of the basic ICP-MS and realize more potential of the technique for practical and varied analyses.

Investment in additional sampling tools allows ICP-MS users to:

- Achieve very high sample throughput compared to conventional nebulization
- Remove sample matrix
- Carry out on-line sample preparation, including dilution
- Directly analyze solid samples that are difficult to digest
- Determine element concentration by species or oxidation state rather than total content

While many sampling methods have been investigated for use with ICP-MS, some have become obsolete, or remain of academic interest, such as spark ablation and slurry nebulization for solids analysis, and electrothermal vaporization (ETV) as a sample introduction device. The most commonly used sample introduction devices in practical analytical applications include:

- Integrated sampling systems
  - Constant flow nebulization
  - Autodilution
  - Discrete sampling
  - Hydride generation
  - On-line matrix removal
  - Low-pressure chromatography
- Laser ablation (LA)
- Desolvation systems
- Chromatography techniques - discussed in Chapter 6

## Conventional Liquid Sample Introduction

Typically, liquid samples are introduced into the ICP using microbore uptake tubing to transport the solution from the sample vial to the nebulizer, often with a peristaltic pump to control the flow of sample solution. Sample uptake flow rate is dependent upon the density and viscosity of the solution being introduced. Using a peristaltic pump to assist sample introduction reduces the variation in uptake flow rate due to variation in these physical parameters, though it does introduce the increased possibility of element retention due to the need to use a soft, mechanically resilient tube for the pump (made from silicone or PVC). The peristaltic pump should be integrated into the ICP-MS hardware such that control of the pump speed can be synchronized with other instrument activities, such as sample uptake, measurement and rinsing. When conventional sample introduction offers insufficient flexibility for sample introduction, an integrated system may be required.

## Integrated Sampling Systems

This is a broad term which covers a range of sample introduction techniques based on fairly simple hardware consisting of peristaltic pumps and switching valves. The extra hardware offers the following benefits: increased sample throughput, expanded measurable concentration range, reduced sample loading in the plasma and on-line chemistries.

An example of an integrated sampling system is Agilent's Integrated Sample Introduction System (ISIS), which is a flexible ICP-MS sampling accessory that can also be used for on-line sample preparation as well as sample introduction. Advantages include:

- High sample throughput through rapid sample introduction and washout
- Enhanced routine analysis through intelligent automated on-line dilution of over range samples
- Discrete sampling for extremely high matrix samples or ultra high sample throughput

# Extending the Capabilities of ICP-MS

The ISIS, in its simplest form, consists of a pair of multi-channel, low-pulsation, peristaltic pumps delivering highly accurate flow rates. Each pump is independently controlled from the ICP-MS data system.

Valves can be added to the basic configuration to allow flow switching, stream selection, chromatography or chelation, extending the capabilities of the ICP-MS system. Note the valve(s) should have low dead-volume to keep the introduced solution as a narrow, discrete “plug” of sample, rather than a broadly tailing plug. This ensures that the solution passes through the system as rapidly as possible – a tailing plug takes longer to wash out than a narrow plug. With the Agilent ISIS the valves are PEEK Cheminert high pressure 6-port valves from Valco Corp, and integrated into the ICP-MS system, so the valve control is also automated through the ICP-MS software.

## Constant Flow Nebulization

ICP-MS productivity can be maximized using an ISIS. Normally sample uptake and rinse out rates of conventional ICP-MS are limited by the maximum flow of the nebulizer or the desire to minimize the instrument exposure to excessive sample flows. ISIS uncouples sample uptake and rinse flow from nebulizer flow, enabling the user to maximize uptake and rinse without considering the limitations of nebulizer maximum flow. In this mode, the instrument is never exposed to high flow rates of sample. Wash in/wash out and stabilization times are reduced to a minimum, increasing sample throughput. In addition, the total amount of sample matrix introduced to the sample introduction system and interface is significantly reduced, minimizing contamination and extending routine maintenance intervals.

## On-line Dilution and Autodilution

The need to dilute the solution prior to analysis by ICP-MS is often a necessary, time-consuming operation that benefits from automation. Dilution can be off-line (prior to loading the sample tube racks), or on-line at the ICP-MS. On-line dilution offers the benefit of minimizing sample handling steps, but some versions of on-line dilutors require a vacant vial to transfer the diluted sample, before analysis.

The dilution can be constant, so every solution introduced into the ICP-MS is diluted by a constant factor, or the dilution can be part of a QC error action, when an element’s measured concentration is greater than the method’s linear calibrated range, then a re-analysis of the high sample, after dilution, is performed automatically prior to the measurement of the next sample.

Intelligent on-line automatic dilution allows the analysis of “out of range”, QC failure or high concentration analytes to be performed within a single automated run. Figure 1 shows the arrangement of the Agilent ISIS for autodilution. Dilution is automatically achieved by changing the ratio of flow rate of sample and diluent, by changing the appropriate peristaltic pump speeds. Samples loaded in the autosampler are delivered to pump #1 along with the internal standard for dilution factor correction (DFISTD). The diluent is added by pump #2 and the diluted sample is mixed by the mixer before splitting the surplus flow to the drain. Finally, the quantitative internal standard (ISTD) is added to the samples by an onboard pump. The sample is then introduced to the nebulizer at constant flow. Agilent’s ISIS supports autodilution factors of 5, 10 and 20x by volume. The relative speed of the two pumps changes depending on the dilution factor selected.

**Figure 1:** Schematic of Agilent ISIS system configured for autodilution

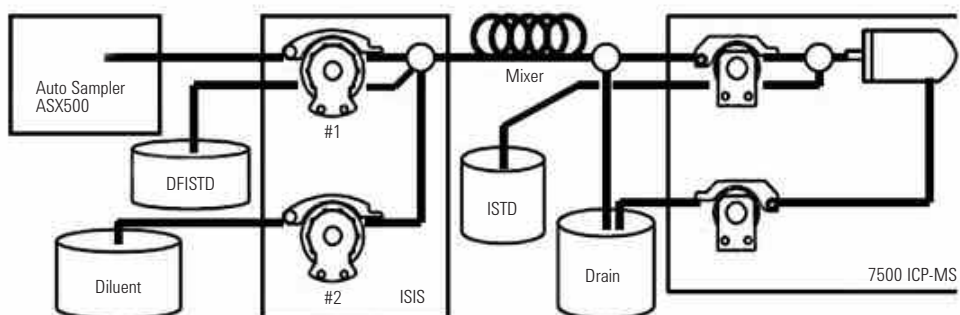

Apart from the time saving by automation, the main advantage of this approach over syringe-pump systems is that extra empty sample vessels are not required and the sample rack of the autosampler can be filled to maximum capacity.

### Discrete Sampling

Discrete sampling allows the analysis of aggressive matrices, percent (%) levels of dissolved solids and small volumes by analyzing a small, fixed amount of sample, rather than a continuous sample stream. The sample volume is injected into a carrier stream and transported to the nebulizer, thereby significantly reducing the total analysis cycle and the total sample matrix loading on the interface. Each sample is loaded into the fixed volume loop in turn and injected into the carrier stream immediately prior to analysis. Between samples, the sample introduction tubing and glassware is constantly flushed with rinse solution and the loop can be filled with the next sample while the previous one is being analyzed. This means that very fast analysis is possible, and the sample introduction system is only exposed to the sample matrix during the actual measurement time. Using discrete sampling, the nebulizer sample exposure is about 20% of the analysis cycle, compared to a nebulizer sample exposure of about 50% with the conventional sample introduction. The lower matrix exposure helps minimize drift when large runs of very high matrix sample are analyzed. Even though the signal produced from discrete sampling is transient in nature, a full analytical suite of elements can be determined by quadrupole ICP-MS without any loss of precision. Detection limits may be degraded with small sampling loop sizes but this is not normally an issue with high matrix samples.

The major benefits of discrete sampling are rapid sample analysis cycles (less than one minute, sample to sample) compared to the more typical 4-5 minutes per sample, and improved matrix tolerance with extremely high matrix samples.

### Hydride Generation

Hydride generation yields ultimate detection limits for Ge, As, Se, Sn, Sb, Te, Pb, and Bi which are elements that react with reducing agents to form gaseous hydrides. Sample solution is mixed on-line with a reducing agent, such as sodium borohydride, then acidified, and converted to a metal hydride which is volatile. The gaseous hydrides are separated from the liquid matrix by a gas/liquid separator and subsequently introduced directly into the plasma. The formation of a volatile species isolates the analytes from the matrix, improving the element sensitivity. Hydride generation allows removal of the analyte from interferences, such as the chlorine based interferences on arsenic, thereby improving both reporting limit and reliability of measurement. The Agilent Hydride Generation Accessory, available as an option on the ISIS, features a high performance membrane gas/liquid separator. A hydride generation accessory is not necessary with CRC-ICP-MS instruments such as the Agilent 7500ce or 7500cs, where single figure ppt detection limits can be obtained for all the hydride elements, even in a chloride matrix.

The gas/liquid separator is also useful for the low level measurement of mercury, since mercury is a volatile metal element. Traditionally stannous chloride is used for mercury reduction, prior to analysis by a dedicated mercury analyzer. In ICP-MS, since tin is commonly a required element in the same suite as Hg, the reduction of Hg for ultratrace analysis (sub-ppt) is typically carried out using the same chemistry as for the hydride elements, ie sodium borohydride and HCl.

# Extending the Capabilities of ICP-MS

## Advanced Applications

The ISIS can also be used to carry out on-line matrix removal and low-pressure chromatography, with the addition of low pressure chromatographic columns. By using mini- and micro-columns, some species can be separated without the need for investment in an LC or IC instrument.

## Laser Ablation

Laser ablation (LA) ICP-MS is widely used to determine elements directly in virtually all types of solid samples with minimal sample preparation. It is a highly sensitive technique with a wide analytical dynamic range from the single figure part per billion (ppb) to the percent (%) level in the solid. UV lasers are widely used with ICP-MS because of their highly controllable spatial resolution (spot size) and relatively low cost. Systems with different wavelengths and beam profiles are available depending on the types of samples to be analyzed.

Benefits of the technique include:

- Direct analysis of solids and powders
  - Alleviates need for sample digestion
  - Eliminates introduction of contaminants as sample prep is minimized
  - Dry plasma reduces formation of polyatomic interferences
- Suitable for all kinds of solid materials including geological sample types, ceramics, metals and alloys, biological and forensic samples. Applications include:
  - Surface mapping studies of rocks, minerals and glasses to establish elemental distribution and migration
  - Bulk sampling of metals, alloys, nonconductive polymers and ceramics for elemental content
  - Feature analysis of micro-inclusions and small spots (<5  $\mu\text{m}$ )
  - Depth profiling studies of thin films and coatings

**Figure 2:** Schematic of a Nd:YAG Laser Ablation system

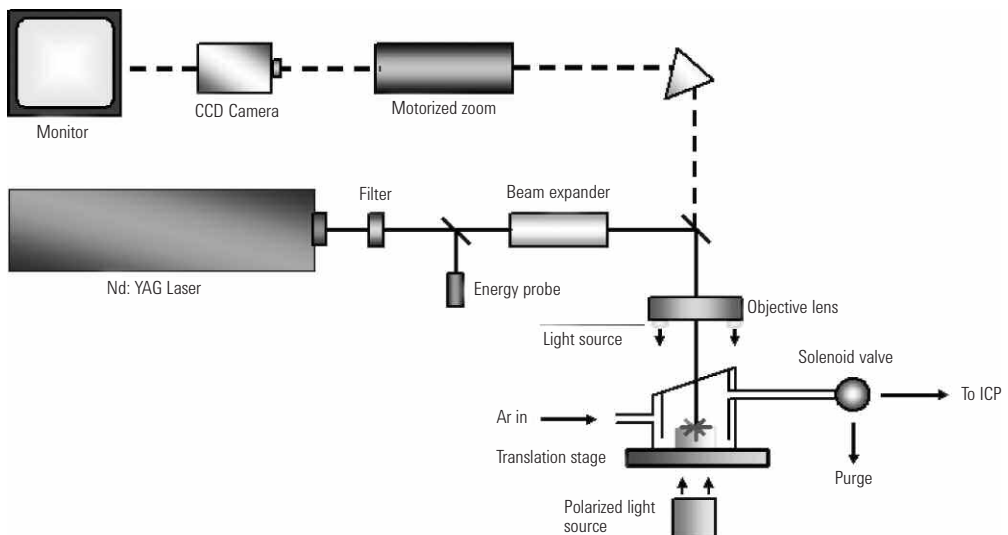



## Principles of LA for ICP-MS

Most laser ablation systems used with ICP-MS utilize a Nd:YAG (neodymium doped yttrium aluminum garnet crystal) laser to generate a high intensity pulsed light beam at a fundamental frequency of 1064 nm. This is frequency quadrupled or quintupled to the analytically useful ultraviolet wavelengths of 266 nm or 213 nm respectively. The beam is focused onto the sample surface in an ablation chamber or cell, which is purged with argon or helium – see Figure 2. The beam diameter can be accurately set by software-controlled apertures to produce variable “spot” sizes typically from <math><5 \mu\text{m}</math> to 750  $\mu\text{m}</math> depending on the application and type of laser being used. The laser light couples to the surface of the sample, causing very rapid heating, which in turn, causes the matrix to be volatilized or ablated. The resultant laser-induced aerosol is then transported to the ICP in an argon carrier gas stream where it is decomposed, atomized and ionized, before extraction into the mass spectrometer vacuum system for analysis. A high magnification video system$

enables a full color, high-resolution image of the sample to be viewed directly on the ICP-MS monitor in real-time (see Figure 3), and the data generated from LA-ICP-MS can be manipulated in real-time to enable the user to view the results of an analysis within seconds of data acquisition.

The nature of the signal produced by laser ablation presents certain analytical challenges for successful analysis by ICP-MS. When the laser interacts with a heterogeneous sample surface, the resultant signal may vary significantly and, in the case when fluid or gas inclusions are analyzed, changes may be rapid. Also, the concentrations of sample components in some solid samples often vary from major (%) to trace (ppb) levels.

For successful analysis of these types of signals, the ICP-MS should have a wide dynamic range and an extremely high scan speed to manage the transient nature of the LA signal. A quadrupole-based instrument is ideal, as long as the ion transfer and detector systems are capable of rapid data acquisition.

**Figure 3:** Screen capture showing a high-resolution image of the sample being analyzed

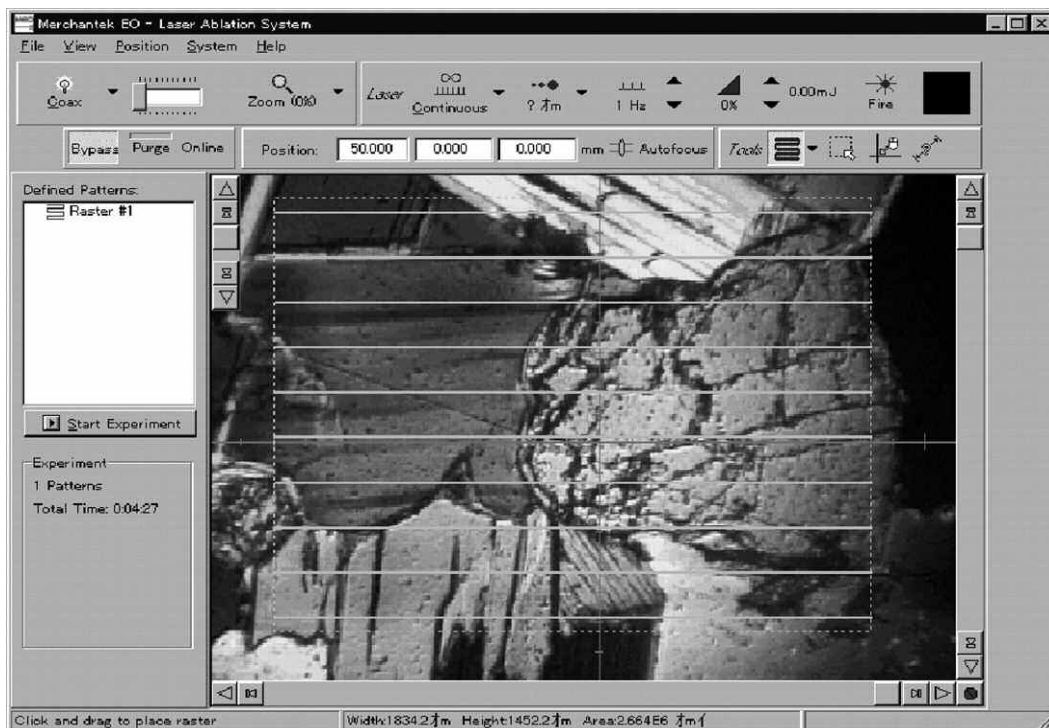

## Extending the Capabilities of ICP-MS

Probably the biggest limitation of LA-ICP-MS is the limited availability of calibration standards, required for full quantitative analysis. Calibration standards are available for some metals and polymers as well as glasses, ceramics and some synthetic copies of materials such as bone. While some of these materials are not very well characterized for a wide range of trace elements, the availability of these standards and other "in-house" reference materials does mean that LA-ICP-MS is starting to be accepted for quantitative analysis in some routine laboratories. For the semiquantitative and feature analysis of solids, however, LA-ICP-MS is an excellent technique.

Excimer-based and solid state lasers operating at 193 nm are also becoming more popular for geochemical research because of the improved coupling between deep UV light and materials such as quartz, mica and  $\text{CaF}_2$  which are transparent to visible light. Another benefit is that materials ablated with far UV wavelength lasers (eg 193 nm) tend to form smaller and more consistent particle sizes, which leads to less elemental fractionation when the particles reach the plasma (fractionation occurs when different elements have different sensitivity due to different volatilities).

### Other Solids Analysis Techniques

Spark Ablation and Slurry Nebulization are two other solids analysis techniques which generated some early academic interest but never found common use in ICP-MS. Spark ablation generates a sample aerosol from a voltage applied to a conducting sample – however the sampling load on the plasma and interface was generally found to be too high, leading to contamination of the interface and ion lenses. Slurry nebulization is a method to sample fine powders by ultrasonication of a slurry of the sample in water with a surfactant added.

### Desolvation Systems

Desolvation devices, as the name suggests, are used in ICP-MS to reduce the amount of solvent entering the plasma. The main benefits of a desolvated aerosol are:

- A higher plasma temperature through reduced solvent loading of the plasma
- An opportunity to deliver more sample material to the plasma
- Removal from the aerosol of a high proportion of the components which could otherwise combine to form polyatomic interferences (O and H, for an aqueous sample)

The most common desolvation devices include:

- Chilled spray chambers
- Ultrasonic nebulizers with desolvation
- Conventional nebulizers with desolvation

See Spray Chamber Temperature section on page 11 for a discussion on how water-cooled and Peltier-cooled spray chambers can influence the amount of solvent vapor entering the plasma.

### Ultrasonic Nebulizers with Desolvation

An ultrasonic nebulizer (USN) produces a very high proportion of transportable aerosol (very small mean droplet size) and is commonly used to increase the sensitivity of ICP-OES instruments. The inherent high sensitivity of ICP-MS means that the further enhancement available from a USN is very rarely required. Indeed, the USN can be disadvantageous in ICP-MS, since the increased aerosol transport efficiency means that the sample matrix loading is also increased, leading to more cooling of the plasma and a higher level of matrix deposition on the interface cones, which in turn can give rise to signal drift.

Adding a condenser-type desolvation device between the aerosol generator and the plasma can reduce the cooling effect of the USN's dense aerosol. A desolvator consists of a heater, which converts the water (or other solvent) content of the sample into vapor, followed by a condenser, which removes this vapor from the carrier gas stream. The main disadvantages are that the ultrasonic transducer, heater and condenser add considerably to the surface area with which the sample comes into contact, so cross-contamination can occur and washout times are increased. Finally, the heating step leads to loss of volatile elements, so a USN with desolvator is incompatible with the measurement of elements such as Se, As and Hg. USNs and conventional nebulizers with membrane desolvation suffer from the same limitations due to loss of volatile analytes.

### Conventional Nebulizers with Desolvation

The same limitations as with USNs apply to these devices when used with ICP-MS. Probably the only application which they are used is when ultra-high sensitivity is required, and the analyte is not common, so backgrounds and cross contamination are not such an issue – an example would be ultratrace actinide determination in pristine environmental samples such as Arctic ice.

### Electrothermal Vaporization

An ETV device is essentially an Electrothermal Analyzer (ETA), as used in GFAAS, but modified for connection to ICP-MS. ETV devices found limited use in the early 1990's as a way to overcome Ar-based polyatomic interferences such as ArO in semiconductor applications. ETV-ICP-MS was notoriously difficult to use, slow, and essentially made ICP-MS a single element analyzer. With the advent of cool plasma and later CRC-ICP-MS for the removal of polyatomic interferences, ETV was effectively rendered obsolete.



## Section 6 – Hyphenated ICP-MS

Hyphenated techniques involving ICP-MS are among the fastest growing research and application areas in atomic spectroscopy. This is because, by itself, ICP-MS does not give information on the chemical or structural form of the analytes present (since all forms of the analytes are converted to positively charged ions in the plasma). However, as an excellent elemental analyzer, it also performs as a superb detector for chromatography [1]. Hyphenated ICP-MS is achieved through the coupling of the ICP-MS to a separation technique – normally a chromatographic separation. In this way, target analytes are separated into their constituent chemical forms or oxidation states before elemental analysis. Most common separation techniques are gas chromatography (GC), liquid chromatography (LC) and ion chromatography (IC), but other separation techniques such as capillary electrophoresis (CE) are also used. This chapter is limited to the use of ICP-MS as an elemental detector for GC, LC, IC and CE, though the same principles would apply to other similar techniques. Because of its ability to accurately distinguish isotopes of the same element, particularly now that collision/reaction cell (CRC) technology has all but eliminated interferences, ICP-MS is also capable of isotope dilution (ID) quantification [5].

For convenience, hyphenated ICP-MS can be divided into two application areas, elemental speciation and molecular speciation. The differences are subtle, as the ICP-MS is always measuring elemental signals, but the distinction arises from whether the elements being separated and detected are present in the sample in the elemental state, as in the case of Cr(III)/Cr(VI) species, or as part of a larger molecule, such as a brominated flame retardant.

**Elemental speciation** is important in many application areas and is becoming particularly important in the environmental, food, and clinical industries. This is because, for many elements, properties such as those listed below depend on the species or chemical form of the element present in the sample.

- Toxicity or nutritional value
- Environmental mobility and persistence
- Bioavailability
- Volatility
- Chemical reactivity

A common example would be the measurement of Cr (VI) – toxic – and Cr (III) – non-toxic – as opposed to total Cr in environmental samples. Similar examples of elemental speciation include As (III)/As (V), Se (IV)/Se (VI) and other elements that can exist at different stable oxidation states.

**Molecular speciation** is another application of hyphenated ICP-MS [2,3,4,5]. In this case, the ICP-MS is able to identify and quantify the presence of a particular element or elements in molecular chromatographic peaks. When used in conjunction with organic MS techniques [4,6], this technique can permit quick screening for molecules (peaks) containing specific elements in a complex mixture, prior to analysis by organic MS. With modern, integrated systems and software, simultaneous analysis by ICP-MS and organic (e.g. ESI) MS is also possible, using a split flow from a single chromatography device.

In addition to the more conventional liquid-based separations (HPLC and IC, for example), ICP-MS is also a superb detector for separations carried out by GC. While other element specific detectors exist for GC, none possess the elemental coverage, sensitivity or specificity of ICP-MS. Examples of ICP-MS in molecular speciation are many and cover a broad variety of applications:

- Total sulfur and sulfur species in hydrocarbon fuels
- Organotin species in marine sediments and biota, consumer goods and drinking water
- Mercury species in fish, industrial discharges, and petroleum processing
- Arsenic species in marine algae, food products and drinking water
- Brominated and phosphorus based flame retardants in consumer goods
- Phosphorus and sulfur in biological samples
- Protein bound metals
- Pesticides and herbicides
- Chemical warfare agents
- Volatile organohalides in air samples

For success, all hyphenated ICP-MS systems require that a few simple conditions be met.

1. The connecting interface must physically transmit the fractionated sample from the separation system (called chromatograph from here on) to the plasma of the ICP-MS in a form that the plasma can tolerate, without the loss of sample integrity. The sample must not be changed in any way and the temporal resolution of the sample components must not be unacceptably degraded.
2. The chromatograph should communicate with the ICP-MS to allow synchronous separation and detection.
3. The ICP-MS must be capable of transient signal acquisition at sufficient sampling frequency and over sufficient dynamic range to accommodate the required number of species and elements over their ranges of concentrations.
4. It must be possible to tune the ICP-MS under plasma conditions similar to those encountered during the chromatographic run. Generally, this entails introducing the tuning element(s) via the chromatography interface.

In general, using an ICP-MS as a detector for chromatography is a simple matter of connecting the outlet of the column to the sample introduction system of the elemental analyzer. If the sample is gaseous, as in GC, the transfer line should be heated to eliminate condensation and will terminate directly into the ICP torch. If the sample is a liquid, the transfer line will likely terminate in a nebulizer in order to generate an aerosol compatible with the plasma. This may require either a split flow or makeup flow in order to match the chromatographic flow with the nebulizer requirements. Depending on the total sample flow and choice of nebulizers, the use of a spray chamber may or may not be necessary.

## GC-ICP-MS

ICP-MS offers several advantages over other detectors for certain GC applications.

- Element (isotope) selectivity
- High sensitivity (sub pg for most elements)
- Universal (almost any element; almost any sample).
- Matrix tolerance (minimal suppression, unlike many traditional chromatographic detectors)
- Large linear dynamic range ( $10^9$ )
- Rapid scanning (minimum dwell time is 100 us per isotope)
- Complementary with other mass spectrometric detectors
- Compound/species independent response

While ICP-MS offers several benefits as a GC detector, most existing GC methods can be transferred directly to GC-ICP-MS with little or no modification. Existing sample preparation methods (extraction, derivatization, etc) are typically compatible with the GC-ICP-MS method and, because of the tolerance of the ICP to a range of carrier gas types and flows, the GC-ICP-MS method may even be faster or simpler to operate than the traditional method.

There are GC applications for which ICP-MS is not an appropriate choice. These would include those where another, simpler, less costly detector could do the job, such as simple hydrocarbon analysis. Also included would be applications requiring the detection of F, N, O, H, He, Ne or Ar, since ICP-MS cannot measure these elements. Additionally, if molecular or structural information is necessary, a different MS technique would be required, possibly after screening by ICP-MS.

GC-ICP-MS is both the most difficult and the easiest of the hyphenated techniques. It is difficult because the transfer line between the GC and ICP-MS must be inert, as short as possible and uniformly heated to sufficient temperature to prevent sample condensation. It is easy because, from the standpoint of the ICP-MS, there is virtually no matrix (the matrix being the small flow of He or H<sub>2</sub> used as GC carrier gas).

Figure 1 depicts the Agilent GC-ICP-MS interface, which has been available commercially since 2002. The heated transfer line is capable of maintaining uniform temperature from the outlet of the GC column inside the GC oven to the tip of the ICP injector at the base of the plasma. This is accomplished through the use of two independent heated zones and extensive thermal insulation. In addition, the ICP carrier gas, which is typically about 1 liter min<sup>-1</sup> of argon is preheated via a heat exchanger inside the GC oven and then passed through the transfer line before entering the plasma. This helps maintain uniformly high temperature within the transfer line and sweeps the sample from the GC column rapidly and inertly into the plasma.

Since there is no matrix (water, acid or solvent), other than the brief solvent peak at the beginning of the run, plasma conditions in GC-ICP-MS are very different from normal "wet" plasma conditions. In the absence of aqueous or organic solvent background, polyatomic interferences are virtually non-existent. As a result, CRC technology is generally not necessary for most GC-ICP-MS applications. Furthermore, without the cooling effect of the solvent, the plasma can achieve much higher temperatures at much

**Figure 1:** Schematic diagram of Agilent GC-ICP-MS system.

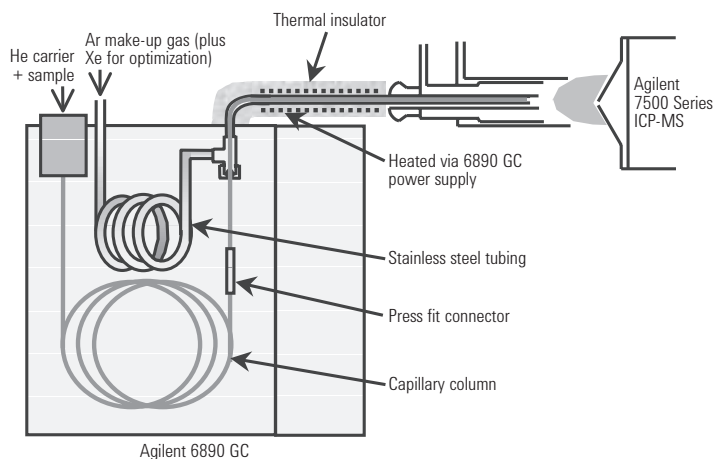

lower RF power settings. Typical RF power when using the Agilent GC interface is 600-900 watts, and these sampling conditions are by no means “cool plasma” providing efficient ionization of poorly-ionized elements such as P, S and the halogens.

### Tuning and Optimization of ICP-MS for GC Applications

Tuning the ICP-MS typically requires optimization of the:

- Plasma for efficient ion production
- Ion optics for best sensitivity
- Quadrupole for mass resolution and mass calibration
- Detector for sensitivity and linear dynamic range

In conventional ICP-MS, these conditions are met by aspirating a tune solution containing several elements upon which the system is optimized. However in the case of GC-ICP-MS, the liquid sample introduction system is not fitted and the plasma conditions are sufficiently different that a solution based tune would not be appropriate. In this case, tuning and optimization must be carried out using a gaseous tune sample. Normally, this is accomplished through the addition of 0.05% - 0.1% xenon in helium, either in the GC carrier gas or in an alternate GC carrier used only for tuning. Using multiple Xe isotopes can optimize all necessary tuning parameters. If very low mass calibration or detector optimization is required, other gases can be used such as CO<sub>2</sub>, Kr, etc.

### Use of Optional or Auxiliary Gases

The addition of optional gases is well documented in GC-ICP-MS [11]. These gases can serve two purposes.

1. The addition of oxygen to the argon carrier gas can eliminate the accumulation of carbon on the injector tip and interface cones from hydrocarbon solvents.
2. The addition of oxygen or other gases including nitrogen and helium has been shown to significantly enhance the sensitivity for some elements.

As a result, for most applications, at least one, but more often two auxiliary gases will be required. It is desirable for the gases to be under mass flow control, especially since they will be subjected to varying back pressure as the GC oven heats and cools during the run. Furthermore, it is advantageous to be able to time program the addition of auxiliary gases, since they may be needed at different times during the run. For example, the addition of oxygen is really only needed at the beginning of the run, during the elution of the solvent peak, and may at other times cause potential polyatomic interferences. By time programming the O<sub>2</sub> addition as a short O<sub>2</sub> pulse at the beginning of the run, the solvent is burned off and the formation of oxygen-based polyatomics during the rest of the run is eliminated. By using the three channel auxiliary Electronic Pressure Control (EPC) flow modules on the Agilent 6890 GC, this is easily achieved.

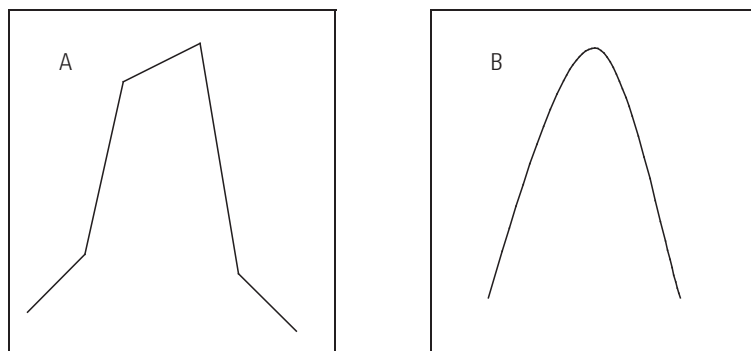

**Figure 2:** The effect of sampling rate (scan rate) on chromatograph peak shape. (a) – too few scans to accurately define the peak shape resulting in imprecise and inaccurate quantification, (b) – sufficient number of scans for accurate quantification



## ICP-MS Setup

ICP-MS set-up for GC-ICP-MS is quite simple and only a few rules and requirements need to be adhered to. First, the ICP-MS must be capable of rapid time resolved acquisition, since capillary GC peaks may be quite narrow. A good rule for accurate and precise integration of chromatographic peaks is to acquire at least 10 data points across the peak width. In ICP-MS, as in other scanning MS techniques, each data point requires a minimum time to collect, based on the number of masses acquired, the time spent on each mass (dwell time) and the quadrupole settling time. This time is called the integration time, which should be less than 1/10 the peak width. This can be optimized by controlling the number of isotopes (masses) and the dwell time, and possibly by controlling the GC peak width chromatographically. Typical capillary GC peaks are 5-10 seconds wide, meaning that the ICP-MS integration time must be less than 0.5 to 1 second per scan. Due to the use of fixed ion lens and CRC voltages, the variable quad settle time and the high speed detector electronics used on the 7500, this integration time is easily achieved, even for applications where quite large numbers of analytes are monitored (e.g. pesticide screening).

The other concern is that of dynamic range. Within a single GC peak, the signal will go from baseline to max signal and back to baseline, so the actual range of counts per second can be very large. It is not uncommon for this range to exceed the pulse count limit of some ICP-MS detectors. In this case it is critical that the pulse to analog transition is both exact and immediate, since anything less would adversely affect the GC peak shape. It is also critical that the analog detection circuitry is sufficiently fast to follow the rapidly changing intensity as the peak apex elutes. The Agilent 7500 Series instruments use a unique high-speed analog amplifier that can acquire data at the same rate as the pulse amplifier. Figure 2(a) displays an example of a GC peak shape where the scan rate was too slow, resulting in inaccurate peak shape and poor quantification. This could result from too many isotopes, too long a dwell time, or slow analog acquisition. 2(b) shows the correct peak shape that will yield accurate and precise measurements.

## Applications of GC-ICP-MS

Figure 3(a, b, c) show examples of three diverse applications for GC-ICP-MS.

Chromatogram (a) is an extracted ion chromatogram for sulfur at  $m/z$  32 from the analysis of an ASTM gasoline standard for sulfur species and total sulfur. Note that as very little atmospheric oxygen is entrained, the  $^{16}\text{O}^{16}\text{O}$  background is minimal, allowing measurements at the largest sulfur isotope. In this example, compound independent calibration allowed the individual sulfur components to be quantified using the response from a single sulfur compound in the standard, thiophene. By summing the peak areas of all the sulfur-containing compounds and using the thiophene calibration factor, the total sulfur concentration can be calculated [8]. This way GC-ICP-MS can produce measurements of both sulfur species and total sulfur.

Chromatogram (b) is an example of using the ICP-MS to detect phosphorus in common pesticides. In this work, the detection limits obtained were much lower than achieved by conventional phosphorus GC detectors [6, 7, 11].

Chromatogram (c) summarizes the analysis of 14 common congeners of the widely used brominated flame retardant, PBDE, polybrominated diphenyl ether. In this work, detection limits comparable to high resolution GC/MS were obtained, but the measurement times were generally shorter. [Agilent application note 5989-1615EN].

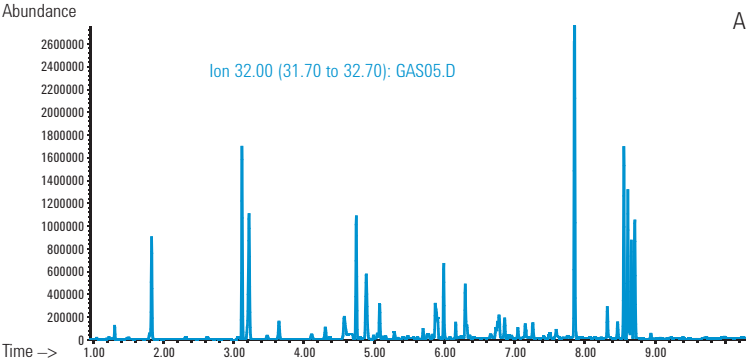

A **Figure 3:** Typical examples of GC-ICP-MS applications

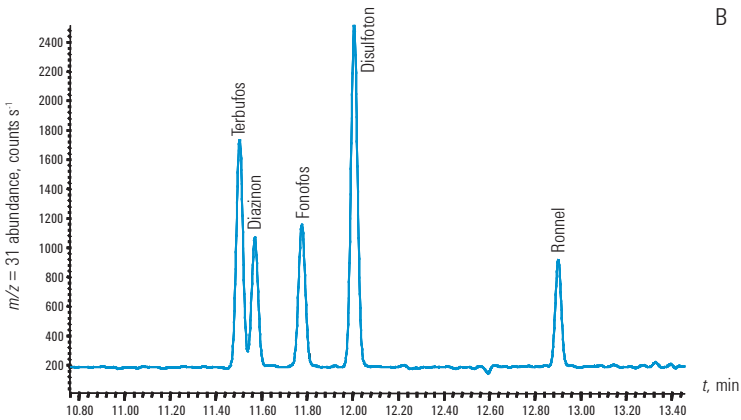

B

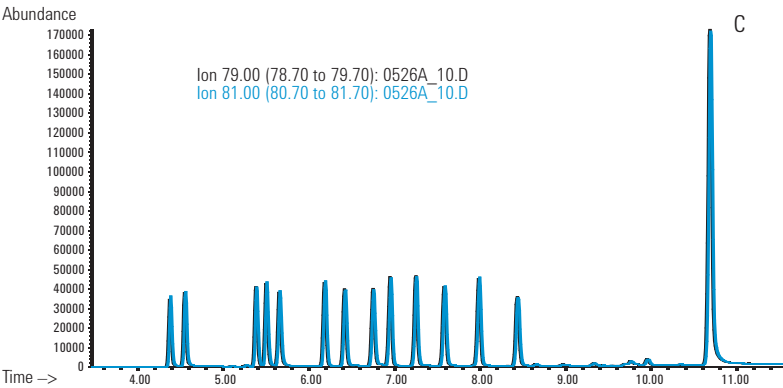

C

## LC (IC)-ICP-MS

Liquid Chromatography (LC) and Ion Chromatography (IC) coupled to ICP-MS will be discussed together, since while the applications are different, the configuration and techniques are essentially identical. LC- or IC-ICP-MS is used for the analysis of non-volatile compounds or ions in solution. The solution can be aqueous, organic or a mixture of both. ICP-MS is the only universal, element specific detector available for liquid chromatography and as such has many applications. Combined with molecular mass spectrometry, ICP-MS can provide a powerful screening tool for metallic markers in biological compounds. When used with ion chromatography, ICP-MS can provide positive elemental confirmation in addition to species identification by retention time.

The Agilent LC connection kit supplies all the components and documentation necessary to interface an Agilent or other HPLC or IC to the Agilent 7500 Series ICP-MS. Essentially it consists of a length of tubing as a transfer line, the necessary connections and fittings, and the APG Remote cable for communication between the LC and ICP-MS.

### Column Connections

The connection of the HPLC column to the nebulizer of the ICP-MS is straightforward, basically being an inert tube with the smallest possible internal volume compatible with the column flow. Connection to the column, or LC detector if a non-destructive detector is used in series, uses standard low dead volume HPLC fittings.

### Matching the Column Flow to the Nebulizer/Spray Chamber

Matching the optimum column flow with the optimum nebulizer flow is critical to achieve both efficient separation and sample nebulization. Since the ICP-MS can tolerate

nebulizer flow rates from essentially zero to in excess of 1 mL/min, the nebulizer is generally selected to match the column flow. Any nebulizer has a range of flows over which it produces the highest proportion of fine droplets in the aerosol. This is critical since fine droplets are more efficiently transported through the spray chamber and atomized and ionized in the plasma. Therefore a nebulizer should be selected which has an optimum flow rate at or near the optimum column flow. For typical LC flows of 0.1 mL to 1 mL/min, conventional concentric nebulizers, either in glass, quartz, or inert polymer work very well. At significantly higher flows, some of the sample will need to be split off prior to the nebulizer. This can be accomplished through the use of a low dead volume Tee near the nebulizer (Figure 4, left). In this case, a self-aspirating nebulizer must be used and avoids the need for a peristaltic pump, which would introduce unacceptable dead volume.

As long as the column flow is larger than the nebulizer self-aspiration rate, there will be positive flow at the split outlet to drain. By positioning the Tee such that the drain flow is on top, any bubbles should preferentially exit at the drain rather than the nebulizer.

A more common situation is one where the column flow is very low and a suitable, conventional nebulizer/spray chamber is not available that can operate at the flow rate. This is the case for micro or nanoflow LC and capillary electrophoresis. There are two options. The first is to use a nano-flow nebulizer. There are devices designed for CE, but can be easily modified for micro or nanoflow LC. The second option is to use a makeup flow added to the column flow in order to meet the flow requirements of the chosen nebulizer and spray chamber. While this makeup flow will dilute the column flow to a degree, this is unlikely to reduce the analyte signal to such an extent that the analysis becomes impractical. There may be some loss

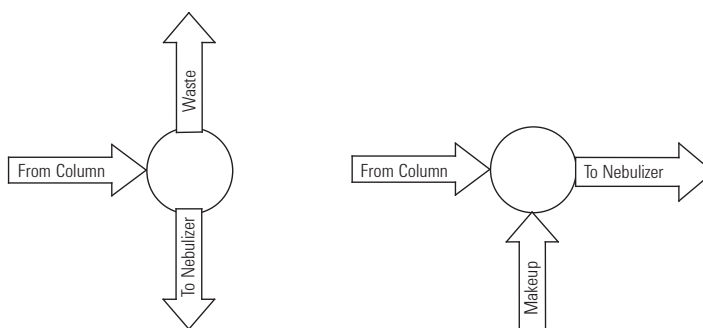

**Figure 4:** Open split (left) and makeup flow (right) configurations for matching nebulizer flow to column flow in LC-ICP-MS

however, depending on the transport efficiency of the nebulizer/spray chamber selected. This second option has an additional benefit of providing a post column internal standard, which can be used to correct for instrument drift or matrix effects due to gradient elutions. The makeup flow, with or without internal standard, can be supplied by a peristaltic pump, or if higher precision is desired, by a piston-type LC pump.

### Tuning and Optimization of ICP-MS for LC Applications

Tuning and optimization for LC applications are essentially the same as for conventional direct nebulization ICP-MS, except that most LC applications involve an organic solvent-based mobile phase, which the ICP-MS must be configured to handle (e.g. through the addition of the solvent introduction kit). A tune solution containing elements intended to cover the desired mass range and indicate potential interferences is introduced and the instrument is tuned as normal. However a couple of factors may need to be considered. The first, and most important, is the effect of the matrix, in this case the LC mobile phase, which may be a simple aqueous solution, an organic solvent, or more commonly a gradient containing both. Since instrument optimization for sensitivity and interference reduction may be dependent on the sample matrix, it is important to use a tune solution made up in the mobile phase and introduced at typical LC flow rates. This is more complicated when the mobile phase is a gradient between widely differing solvents and ionic strengths. In this case it may make sense to optimize the system at somewhere near the midpoint of the gradient, or at the gradient composition where the main compounds of interest elute. In the unusual case where it is

necessary to optimize differently over the entire gradient, the Agilent 7500 ChemStation provides a mechanism called Time Program Acquisition. Time Program Acquisition allows the user to program the ICP-MS acquisition parameters, including tune conditions, as a function of run time. In this way, the tune conditions can be updated several times during the run to match the eluent composition.

### ICP-MS Setup

Setup of the ICP-MS acquisition parameters for LC-ICP-MS follows the same rules outlined in the GC section. The same constraints apply, except that LC peaks are generally much wider, which permits longer integration times. Therefore, longer dwell times, more isotopes or both may be permissible.

### Applications of LC(IC)-ICP-MS

Since LC-ICP-MS does not require any special hardware beyond the LC and the ICP-MS, it was the first hyphenated technique to be thoroughly explored. As a result, the number and variety of LC-ICP-MS applications is large. Virtually any liquid chromatographic application can use ICP-MS as a detector. In fact in some cases, ICP-MS is the only suitable detector. This is because other common LC detectors require specific sample characteristics, such as a UV chromophore, or the ability to ionize easily using conventional MS ionization sources such as electrospray or MALDI. Not all samples lend themselves to these detection schemes. In addition, the very high sensitivity of ICP-MS for most elements can significantly lower limits of detection for many elements or compounds. Example applications are given in Figures 5, 6, 7 and 8.

CHEMICAL WARFARE AGENT	CHEMICAL WARFARE DEGRADATION PRODUCTS	ANALYTICAL METHOD	DETECTION LIMITS NG ML <sup>-1</sup>
<chem>CC(=O)P(=O)(SCCN(C)C)C</chem> VX	<chem>CC(=O)P(=O)(O)OCC</chem> EMPA	Ion Mobility Mass Spectrometry	560-1700
<chem>CC(=O)P(=O)(F)OC(C)C</chem> Sarin	<chem>CC(=O)P(=O)(O)OC(C)C</chem> IMPA	LC-ESI-TOF	80-1000
VX and Sarin	<chem>CC(=O)P(=O)(O)O</chem> MPA	Electrophoresis Microchip with Contactless Conductivity Detector	48-86
		RP-IP-HPLC-ICP-MS	0.139-0.263

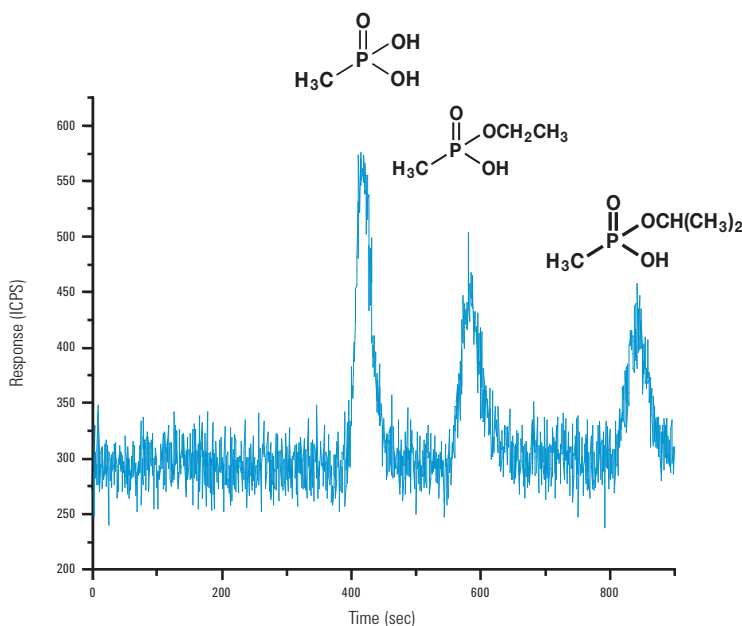

**Figure 5:** Reverse phase ion pairing HPLC-ICP-MS analysis of chemical warfare agent metabolites; EMPA, IMPA and MPA using phosphorus detection.

Data courtesy: Douglas D. Richardson, Baki B.M. Sadi, and Joseph A. Caruso

Department of Chemistry, University of Cincinnati, McMicken College of Arts and Sciences, Cincinnati, Ohio 45221-0172, USA

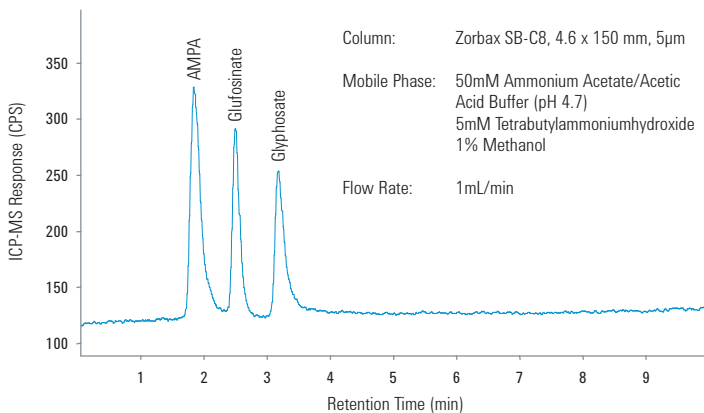

**Figure 6:** LC-ICP-MS analysis of the phosphorus containing herbicides glyphosate, glufosinate and the metabolite AMPA.

Data courtesy: Anne Vonderheide et. al. University of Cincinnati

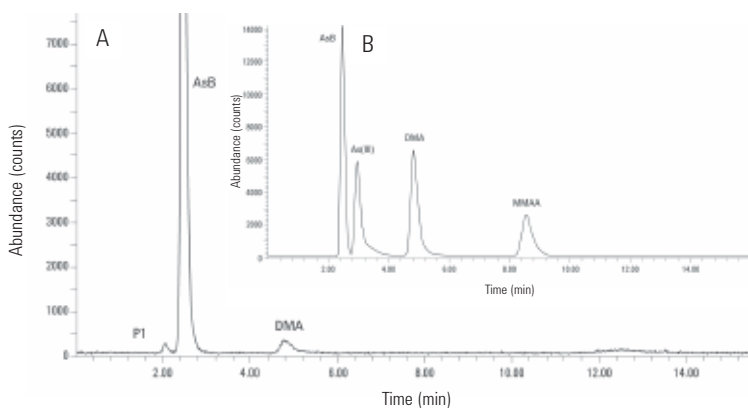

**Figure 7:** Arsenobetaine in tuna fish extract (BCR-627) (a) and standard (b)

Data courtesy: R. Wahlen, LGC, Fast and Accurate Determination of Arsenobetaine in Fish tissues using HPLC-ICP-MS [Agilent application note 5988-9893EN]

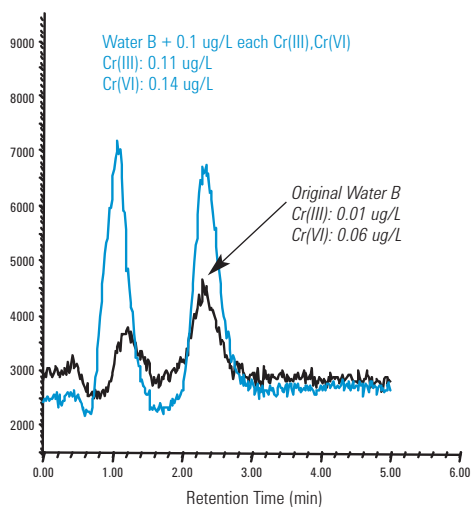

**Figure 8:** Analysis of Cr (III) and Cr (VI) in natural mineral water (unspiked and spiked with 0.1 ug/mL each Cr (III) and Cr (VI)), by ion chromatography-ICP-MS. Mobile phase: 5 mM EDTA (pH 7.0); Flow rate: 1.2 mL/min; Injection volume 500 µL; Sample addition 5 mM EDTA (pH 7). [Agilent application note 5989-2482EN]

## CE-ICP-MS

Capillary electrophoresis (CE) or capillary zone electrophoresis (CZE), in its native form, is not a chromatographic technique because it does not use a pressure generated flowing mobile phase, but rather an electric field to force the migration of charged molecules (sample, buffer or both), through a buffer (or gel) filled capillary. However, the net effect is the same in that species are separated in time based on their relative mobility through the capillary. A wide variety of variations on this general concept exist that can achieve sample separations based on size, chemistry, charge, isoelectric potential and more. The main strengths of CE have been its very high resolution, flexibility of applications and hardware simplicity. The main disadvantages are mostly related to the very small sample size limitations. CE-ICP-MS remains largely in the realm of academia and research and recently, micro and nanoflow HPLC have delivered many of the benefits of CE without some of the disadvantages.

CE differs from LC in several other important ways. Very high voltage (up to 30 kV) applied across the capillary is necessary to cause sample migration and therefore the system must be shielded to protect the user from electric shock. Also, CE sample volumes and “flows” are very low, in the nL/min range. This is advantageous when sample size is very limited as in many biological applications. It is disadvantageous in that very little analyte reaches the detector, limiting the sensitivity of the technique. This is where ICP-MS can provide a solution, due to its very high sensitivity and low sample flow requirements. However, even the most efficient low flow nebulizers for ICP-MS still operate in the low  $\mu\text{L}/\text{min}$  range, many times higher than CE flow. To compensate for this, the

CE-ICP-MS interface must augment the flow as well as electrically isolate the capillary from the ICP nebulizer. Figures 9a and 9b show two commercially available CE-ICP-MS interfaces schematically.

Virtually any compound or element that can be separated by CE can be detected by ICP-MS, providing sufficient material reaches the plasma. In this respect, CE applications are very similar to those by LC; however, since CE always requires a makeup flow, and gradient elution is not used, matrix composition in CE is essentially constant.

### CE-ICP-MS Setup

Setting up the CE-ICP-MS is very similar to the set-up of LC-ICP-MS with a few minor differences. Since the flow is so low, makeup flow is always necessary. It is also desirable to use the lowest flow, highest efficiency nebulizer possible in order to minimize dilution and maximize sample transport to the plasma. If the nebulizer flow is low enough (a few  $\mu\text{L}/\text{min}$  or less), it is desirable to eliminate the spray chamber and transport the nebulizer aerosol directly to the plasma. In this way 100% of the sample is introduced into the plasma for maximum sensitivity. Additionally, since the peak width in CE can be very narrow, rapid scan times are necessary. The same constraints explained in the GC-ICP-MS section must be carefully adhered to.

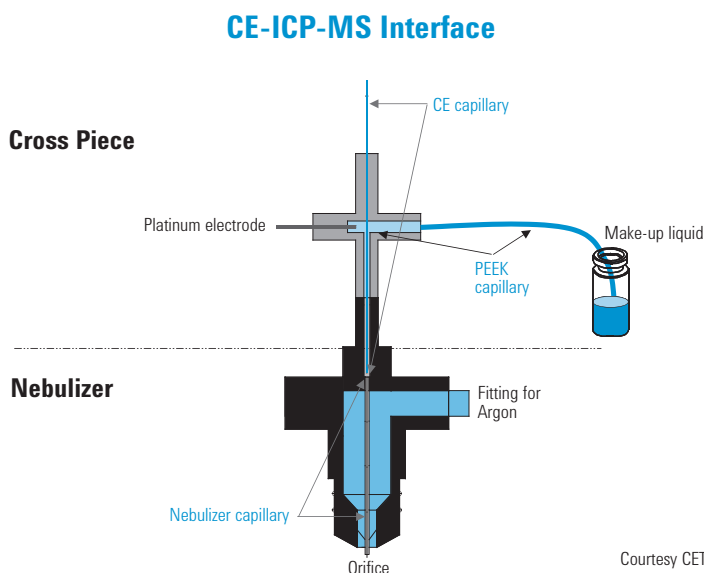

**Figure 9a:** Schematic diagram of Cetac CEI-100 CE-ICP-MS interface

Courtesy CETAC

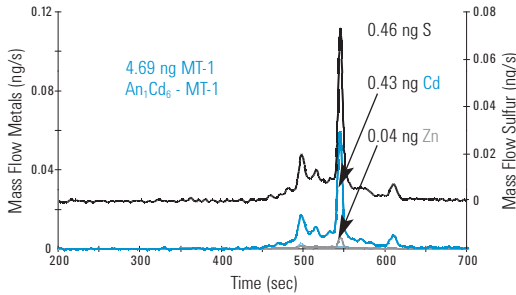

**Figure 10:** Mass-flow-electropherogram of rabbit liver MT-1. Courtesy CETAC, Omaha, NE and GKSS, Geestacht, Germany

## Applications of CE-ICP-MS

Because the basic capillary electrophoresis hardware is capable of so many variations and configurations in separation technology, the number of applications is large and varied. Figure 10 is an example of just one important application, in this case the measurement of metals bound to rat liver metallothioneins (MT) after separation using capillary zone electrophoresis (CZE) with online isotope dilution for sulfur quantification.

Many other applications of CE-ICP-MS exist from simple ion fractionations to the separation of large biomolecules.

## References

1. Speciation analysis with HPLC-mass spectrometry: time to take stock  
*Kevin A. Francesconi, Michael Sperling, Analyst, 2005, (7),998-1001*
2. Determination of iodinated phenol species at parts-per-trillion concentration levels in different water samples by solid-phase microextraction/offline GC-ICP-MS  
*Rodolfo G. Wuilloud, Jorgelina C. A. de Wuilloud, Anne P. Vonderheide, Joseph A. Caruso, J. Anal. At. Spectrom., 2003, (9),1119-1124*
3. Iodine speciation studies in commercially available seaweed by coupling different chromatographic techniques with UV and ICP-MS detection  
*Monika Shah, Rodolfo G. Wuilloud, Sasi S. Kannamkumath, Joseph A. Caruso, J. Anal. At. Spectrom., 2005, (3),176-182*
4. Identification of water-soluble gamma-glutamyl-Se-methylselenocysteine in yeast-based selenium supplements by reversed-phase HPLC with ICP-MS and electrospray tandem MS detection  
*Heidi Goenaga Infante, Gavin O Connor, Margaret Rayman, Raimund Wahlen, Jullian E. Spallholz, Ruth Hearn, Tim Catterick, J. Anal. At. Spectrom., 2005, (Advance Article)*

## MIRA MIST CE Schematic

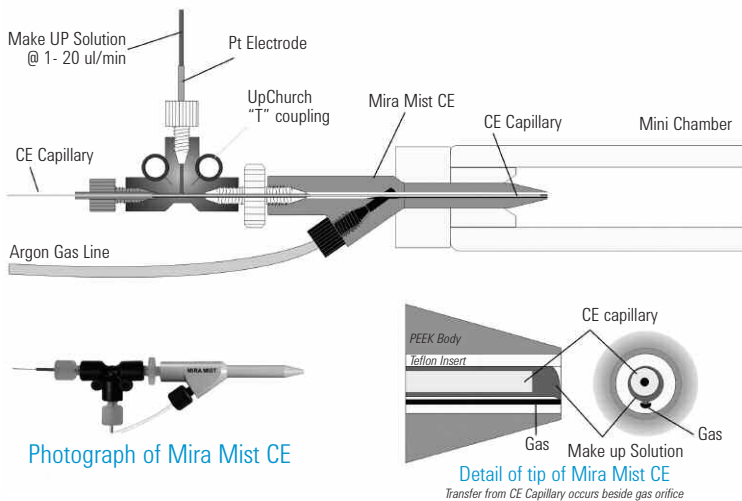

**Figure 9b:** Schematic diagram of Mira Mist CE-ICP-MS interface from Burgener Research



5. Isotope dilution analysis as a definitive tool for the speciation of organotin compounds  
*Pablo Rodríguez-González, Jorge Ruiz Encinar, J. Ignacio García Alonso, Alfredo Sanz-Medel, Analyst, 2003, (5), 447-452*
6. Determination of organophosphorus pesticides in spiked river water samples using solid phase microextraction coupled to gas chromatography with EI-MS and ICP-MS detection  
*Natalia Fidalgo-Used, María Montes-Bayón, Elisa Blanco-González, Alfredo Sanz-Medel, J. Anal. At. Spectrom., 2005, (Advance Article)*
7. Sensitive, simultaneous determination of P, S, Cl, Br and I containing pesticides in environmental samples by GC hyphenated with collision-cell ICP-MS  
*Daniel Pröfrock, Peter Leonhard, Steven Wilbur, Andreas Prange, J. Anal. At. Spectrom., 2004, (5), 623-631*
8. Investigation of the sulfur speciation in petroleum products by capillary gas chromatography with ICP-collision cell-MS detection  
*Brice Bouyssiére, Peter Leonhard, Daniel Pröfrock, Franck Baco, Clementina Lopez Garcia, Steve Wilbur, Andreas Prange, J. Anal. At. Spectrom., 2004, (5), 700-702*
9. Determination of 2,4,6-triiodophenol and its metabolites in human urine by anion-exchange chromatography with ICP-MS detection  
*Rodolfo G. Wuilloud, Niranjana Selar, Sasi S. Kannamkumarath, Joseph A. Caruso, J. Anal. At. Spectrom., 2004, (11), 1442-1447*
10. Determination of phosphorus in phosphorylated deoxyribonucleotides using capillary electrophoresis and high performance liquid chromatography hyphenated to inductively coupled plasma mass spectrometry with an octopole reaction cell  
*Daniel Pröfrock, Peter Leonhard, Andreas Prange, J. Anal. At. Spectrom., 2003, (7), 708-713*
11. Use of optional gas and collision cell for enhanced sensitivity of the organophosphorus pesticides by GC-ICP-MS  
*Anne P. Vonderheide, Juris Meija, María Montes-Bayón, Joseph A. Caruso, J. Anal. At. Spectrom., 2003, (9), 1097-1102*

## AGILENT LITERATURE

5989-3572EN	Determination of Methyl Mercury in Water and Soil by HPLC-ICP-MS
5989-2481EN	Ion Chromatography (IC) ICP-MS for Chromium Speciation in Natural Samples
5988-9880EN	Quantification and Characterization of Sulfur in Low Sulfur Reformulated Gasolines by GC-ICP-MS
5988-9461EN	Speciation of Volatile Selenium Species in Plants using GC/ICP-MS
5988-9893EN	Fast and Accurate Determination of Arsenobetaine (AsB) in Fish Tissues Using HPLC-ICP-MS
5980-0262E	Separation and Analysis of Toxic Arsenic Species Using LC-ICP-MS
5980-0336E	Speciation of Organotin Compounds, Using a Newly Developed, Experimental GC-ICP-MS Interface
5968-8185EN	Determination of Platinum Compounds by LC-ICP-MS
5968-3050EN	Speciation of Arsenic Compounds in Urine of Dimethylarsinic Acid Orally Exposed Rat by Using IC-ICP-MS
5968-3049EN	Specific Determination of Bromate and Iodate in Ozonized Water by Ion Chromatography with Two Detection
5988-6697EN	A Comparison of GC-ICP-MS and HPLC-ICP-MS for the Analysis of Organotin Compounds
5988-3161EN	Automated Real-Time Determination of Bromate in Drinking Water Using LC-ICP-MS and EPA Method 321.8
5968-8232E	Indirect Determination of Fluoride Traces in Natural Waters by Ion Chromatography and ICP-MS Detection
5989-1615EN	PBDE Analysis by GC-ICP-MS: Rapid, sensitive detection of polybrominated diphenyl ethers
5988-9461EN	Speciation of Volatile Selenium Species in Plants Using GC/ICP-MS



## Section 7 – Applications of ICP-MS

ICP-MS is used in virtually every field of analytical measurement, and extensively in the following industries.

- Environmental
- Food and Agriculture
- Semiconductor
- Clinical and Pharmaceutical
- Geological
- Nuclear
- Forensic
- Chemical, Petrochemical

As the applications of ICP-MS are many and varied, it is impossible to supply an exhaustive description of each one. Instead, the following section summarizes a selection of the analytical challenges that have been addressed by the technique, a list of references and relevant Agilent publications. The number given with each Agilent literature title is the publication number, which can be used to search for documents on the company website.

Readers are encouraged to visit the Agilent ICP-MS web site at [www.agilent.com/chem/icpms](http://www.agilent.com/chem/icpms) for free access to over 150 ICP-MS technical and application notes, including the Agilent publications referred to in these summaries. Also included on the Agilent ICP-MS web site is a dedicated methods page called ICP-MS Methods News which gives details of all approved ICP-MS methods currently in use.

## Environmental

The range of applications for ICP-MS in the analysis of environmental samples reflects the diversity of sample types encountered in this industry.

Typical applications of ICP-MS include:

- The determination of trace elements in “clean” samples such as drinking water, rain water and air samples
- The measurement of elements over a wide concentration range in wastewater, sewage sludge, trade effluents, landfill leachates, soil and sediment digests and biota
- The determination of trace and ultratrace elements in high matrix samples such as open ocean seawater [1]

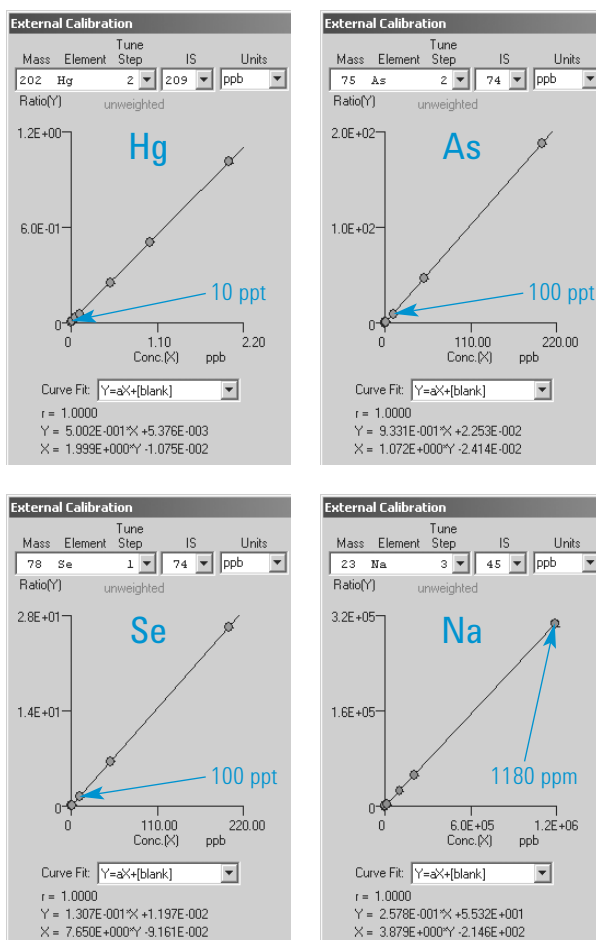

**Figure 1:** Illustration of wide dynamic range and high sensitivity of the 7500ce ORS. Simultaneous measurement at 10 ppt and >1000 ppm. Calibration ranges: Hg: 10 ppt - 2 ppb, As: 100 ppt - 200 ppb, Se: 100 ppt - 200 ppb, Na: 50 ppb - 1180 ppm.

Increasingly, the trend in the environmental testing industry has been to switch to collision/reaction cell (CRC) ICP-MS systems to measure the full range of elements, in all matrices, rather than use a multi-technique approach using ICP-optical emission spectroscopy (ICP-OES) and graphite furnace atomic absorption spectroscopy (GFAAS). The main technical barriers to the sole use of ICP-MS have been the very wide range of analyte concentrations encountered and difficult to resolve interferences on critical elements such as As, Se, Cr, V and Fe. The wide elemental coverage and detector dynamic range of conventional ICP-MS make it highly suitable for the simultaneous measurement of all the required inorganic sample constituents in applications such as the routine monitoring of trace and mineral elements in drinking water [2]. However the 7500ce ORS has been shown to extend the analytical working range further in both directions, enabling low ppt level measurement for Hg, As and Se to 1000 ppm for Na (see Figure 1) in the same analytical run. Additionally, as regulated limits governing environmental monitoring continue to decrease and the requirements for monitoring ultra-trace levels of metals become more important, ICP-MS has the capability to meet future regulated levels, even when new elements such as U, are added to the list of regulated metals.

There are growing requirements to expand the range of elements measured in environmental samples by ICP-MS: for example Be is becoming more important due to its high toxicity, but measurement is required at the ultratrace level. Be is doubly challenging because of its high ionization energy and low mass number. This requires both a plasma with high ionizing power and an ion lens design that has high ion transmission at low mass. These are features found in all 7500 Series instruments (see section 2), giving the 7500 Series unmatched performance for Be. Figure 2 shows a Be calibration with excellent linearity down to 1 ppt, and a DL of 0.052 ppt (52 ppq). This is the best Be performance so far reported using ICP-MS, enabling the 7500ce to uniquely perform Be measurement at the levels currently being requested by some environmental agencies.

**Figure 2:** Be calibration at 1, 10 and 50 ppt (7500ce ORS, no gas mode). Standard sample introduction system was used. Detection limit 0.052 ppt. BEC 0.11 ppt

## References

1. Leonhard, P., Pepelnik, R., Prange, A., Yamada, N. and Yamada, T., 2002, J. Anal. Atom. Spectrom., 17, 189-196
2. Woods, G. D. and McCurdy, E., 1999, in Plasma Source Mass Spectrometry, New Developments and Applications (eds G. Holland and S. D. Tanner) The Royal Society of Chemistry, Cambridge, 108-119
3. Wilbur, S., Soffey, E., McCurdy, E., Real World Analysis of Trace Metals in Drinking Water Using the Agilent 7500ce ICP-MS with Enhanced ORS Technology, 2004, Agilent publication: 5989-0870EN

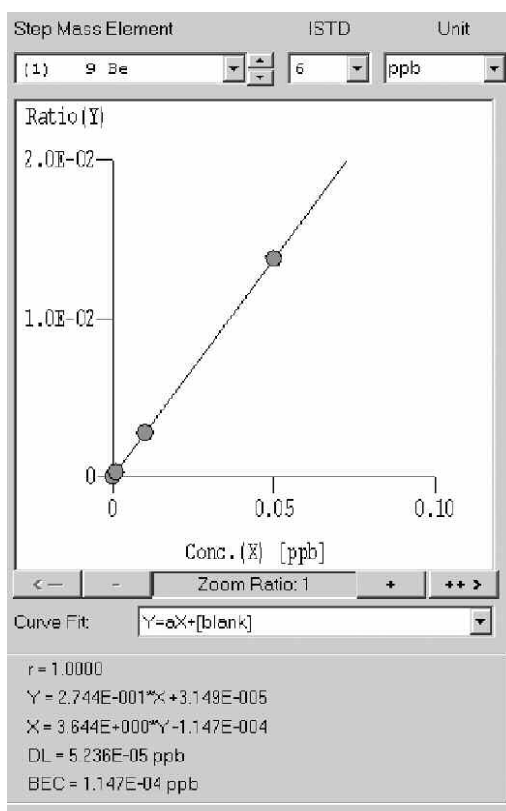

## Food and Agriculture

Trace elements have a major role in human nutrition, and the elemental content of materials is monitored at almost every stage of food production. Furthermore, industrial food production practices and the high proportion of processed food in many diets mean that the natural levels of many essential dietary components must be modified through the use of food additives and supplements. ICP-MS has been applied to the monitoring of trace elements in food materials [1, 2], with applications including monitoring of seasonal and geographical trends in elements with dietary significance [3], determining isotope ratios in elements provided as trace element supplements [4] and measuring metals in proteins to monitor elemental absorption from the diet [5]. In some cases, the trace element content of a food material may provide information about its geographical origin, which may be of interest in cases where the value of the food product is related to its region of production.

Food analysis presents some challenges to ICP-MS in that sample matrices are often complex and it may be necessary to use HCl in sample digestion, which gives rise to Cl-based interferences. Food labs have traditionally used a combination of GFAAS and ICP-OES for metals analysis, but with the advent of CRC ICP-MS, the multiple interferences arising from complex food matrices (and different digestion media) can be resolved. Where food labs have retained GFAAS for certain complex matrix samples and/or problem elements, many are now switching all their metals analysis over to CRC-ICP-MS. Table 1

ELEMENT (UNIT)	ANALYSIS MODE	REFERENCE VALUE	DETERMINED VALUE
Cr (ng/g)	No Gas	940±140	949
Co (ng/g)	No Gas	(250)	229
Cu (ug/g)	No Gas	10.4±1.6	9.1
Zn (ug/g)	No Gas	22.8±2.5	20.7
As (ng/g)	Hydrogen	340±60	350
Se (ng/g)	Hydrogen	(40)	44
Cd (ng/g)	No Gas	18±8	14.7
Ba (ug/g)	No Gas	18.4±1.8	17.7
Hg (ng/g)	No Gas	46±12	58
Pb (ng/g)	No Gas	990±80	922

**Figure 3:** Calibration of 0, 1, 5, 10, 50, 100 ppb S using 7500ce with Xe cell gas. Detection limit 0.33 ppb. BEC 16 ppb.

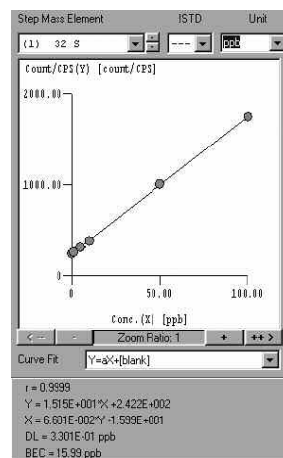

summarizes the analysis of the Chinese Certified Reference Material GBW 08501 Peach Leaf using an Agilent 7500ce ICP-MS.

The peach leaf was digested using nitric acid and hydrogen peroxide in a pressurized PTFE “bomb”. Concentration data was calculated using an external calibration in 0.1% nitric acid.

A growing requirement in foods analysis is for the measurement of sulfur at the same time as other elements. Using the optional low flow cell gas line option, Xe cell gas can be used to remove the O<sub>2</sub> interference on <sup>32</sup>S, allowing sub-ppb detection limits for sulfur. Figure 3 shows a sulfur calibration using Xe mode and a DL of 330 ppt.

**Table 1:** GBW 08501 Peach Leaf CRM analysis using the 7500ce ICP-MS

## References

1. Munro, S., Ebdon, L. and McWeeny, D. J., 1986, *J. Anal. Atom. Spectrom.*, 1, 211-219
2. Dean, J. R., Crews, H. M. and Ebdon, L., 1989, *Applications in Food Science*, in *Applications of Inductively Coupled Plasma Mass Spectrometry* (eds A. R. Date and A. L. Gray), Blackie, London, 141-168
3. Larsen, E. H., Knuthsen, P. and Hansen, M., 1999, 14, 41-44
4. Whittaker, P. G., Barrett, J. F. R. and Williams, J. G., 1992, *J. Anal. Atom. Spectrom.*, 7, 109-115
5. Owen, L. M. W., Crews, H. M., Hutton, R. C. and Walsh, A., 1992, *Analyst*, 117, 649-655

## Semiconductor

There are two main applications of ICP-MS in the semiconductor industry:

- Analysis of ultra-pure water (UPW) and process chemicals used in semiconductor manufacture
- Quality control of semiconductor devices. Requires ultratrace analysis of bulk silicon, Si wafer surface analysis as well as related products such as disk drives and optical materials such as CaF<sub>2</sub> and BaF<sub>2</sub>

The elements typically monitored in semiconductor materials include the alkali and alkaline earth metals, the transition and heavy metal contaminants and elements that are added deliberately as dopants [1]. Until the development of cool plasma ICP-MS, the measurement of the elements K, Ca and Fe could not be achieved by quadrupole ICP-MS at the levels required by the industry. High-resolution ICP-MS can resolve the <sup>40</sup>Ar<sup>16</sup>O interference on Fe at mass 56 [2], but does not have sufficient resolving power to separate <sup>40</sup>Ca from <sup>40</sup>Ar. Since cool plasma ICP-MS became a routine analytical method in 1994 with the introduction of the Agilent 4500, the use of quadrupole ICP-MS in semiconductor laboratories increased dramatically for measurement of these elements, together with the wider suite of metals monitored routinely at ng/L and sub ng/L levels in UPW [3] and many semiconductor process chemicals [4]. With the introduction of the 7500cs, the analyst now has the flexibility of removing interferences using CRC or cool plasma technology [5].

### AGILENT LITERATURE – ENVIRONMENTAL AND FOOD

5989-1041EN	Performance Characteristics of the Agilent 7500ce the ORS Advantage for High Matrix Analysis
5989-0870EN	Trace Metals in Drinking Water using the Agilent 7500ce ICP-MS
5989-0915EN	Analysis of High Matrix Environmental Samples with the Agilent 7500ce ICP-MS
5989-2481EN	Ion Chromatography (IC) ICP-MS for Chromium Speciation in Natural Samples
5989-1585EN	A Comparison of the Relative Cost and Productivity of Traditional Metals Analysis Techniques versus ICP-MS in High Throughput Commercial Laboratories
5989-1492EN	Interference-Free Semiquantitative Analysis using the Agilent 7500ce ICP-MS
5989-1615EN	PBDE Analysis by GC-ICP-MS: Rapid, Sensitive Detection of Polybrominated Diphenyl Ethers
5989-1243EN	Agilent 7500ce – Revolutionary ICP-MS for Trace Metals Analysis in High Matrix Samples
5989-0917EN	Applications of the Agilent 7500ce ICP-MS – Analysis of High Matrix Environmental Samples
5989-0870EN	Trace Metals in Drinking Water using the Agilent 7500ce ICP-MS
5989-0735EN	The New Agilent 7500ce ICP-MS-Revolutionizing Environmental Trace Metal Analysis
5988-9461EN	Speciation of Volatile Selenium Species in Plants Using GC/ICP-MS
5988-9880EN	Quantification and Characterization of Sulfur in Low Sulfur Reformulated Gasolines by GC-ICP-MS
5989-2570EN	Evaluation of Conventional ICP-MS and ORS-ICP-MS for Analysis of Traditional Chinese Medicines
5988-9893EN	Fast and Accurate Determination of Arsenobetaine (AsB) in Fish Tissues using HPLC-ICP-MS
5989-0027EN	Determination of Mercury in Microwave Digests of Foodstuffs by ICP-MS

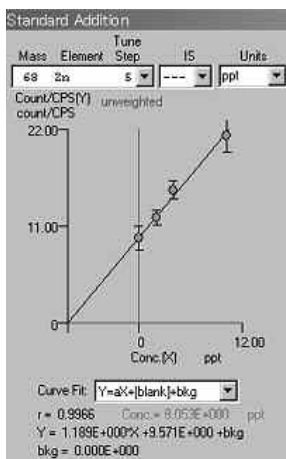

**Figure 4:** Zinc standard addition plot in 9.8% w/w sulfuric acid

### High Purity Acids

The CRC approach to interference removal is preferable to cool plasma for the analysis of certain interfered elements in some high matrix sample types. One example is the analysis of sulfuric acid:

the direct analysis of Zn in sulfuric acid was impossible by ICP-QMS prior to the development of CRC systems due to interference by S-based polyatomics. Applying the 7500cs ORS in He mode to this application, Zn can be measured easily. Figure 4 shows a method of standard additions plot at the low ppt level for Zn in 9.8%  $H_2SO_4$  (w/w) [6].

### Organic Process Chemicals

An area of increasing interest is the control of trace metal contamination in the organic process chemicals such as isopropyl alcohol (IPA) and methanol (MeOH) and the photoresist and stripper materials associated with the wafer masking and etching processes [7]. Demand for multi-element certification of process chemicals, including organic chemicals, at lower levels of metal contamination has led to the adoption of ICP-MS for the analysis, providing both multi-element determination and lower limits of detection. The trace elements measured in organic samples are essentially the same as the elements

monitored in inorganic process chemicals and must be measured at the same concentrations (sub-ng/L or ppt) as in acids and UPW [7].

### Semiconductor Devices

ICP-MS is also routinely applied to the determination of trace elements on the silicon wafer surface, using a technique called Vapor Phase Decomposition (VPD). Here ICP-MS has been shown to have higher sensitivity when compared to the traditional measurement technique of Total Reflection X-Ray Fluorescence (TXRF).

### References

1. Taylor, H. E., Huff, R. A. and Montaser, A., 1998, Chapter 9: Novel Applications of ICP-MS, in Inductively Coupled Plasma Mass Spectrometry (ed A. Montaser), Wiley-VCH
2. Walsh, A., Potter, D., McCurdy, E. and Hutton, R. C., 1991, in Applications of Plasma Source Mass Spectrometry (eds G. Holland and A. N. Eaton) The Royal Society of Chemistry, Cambridge, 12-24
3. Hoeltzlwimmer, R, Fabry, L., Kotz, L. and Pahlke, S., 2000, Fresenius J. Anal. Chem., 366, 64-69
4. Shive, L. W., Ruth, K. and Schmidt, P., 1999, Micro, 17 (2), 27-31
5. Technical Description of Agilent 7500cs ORS ICP-MS, 5988-9881EN, July 2003.
6. Analysis of Impurities in Semiconductor Grade Sulfuric Acid using the Agilent 7500cs ICP-MS, 5988-9190EN
7. McCurdy, E., Woods, G. D. and Mizobuchi, K., 2001, Practical Considerations in the Routine Analysis of Organic Solvents by ICP-MS, paper O-9 presented at the European Winter Conference on Plasma Spectrochemistry, Hafjell, Norway, 4-8 February, 2001

### AGILENT LITERATURE – SEMICONDUCTOR

5989-4348EN	Determination of Impurities in Semiconductor Grade Hydrochloric Acid using the Agilent 7500cs ICP-MS
5989-0321EN	Analysis of Electroceramics Using Laser Ablation ICP-MS
5988-9892EN	Analysis of Impurities in Semiconductor Grade TMAH using the Agilent 7500cs ICP-MS
5988-9529EN	Characterization of Trace Impurities in Silicon Wafers by High Sensitivity Reaction Cell ICP-MS
5988-9190EN	Analysis of Impurities in Semiconductor Grade Sulfuric Acid using the Agilent 7500cs ICP-MS
5988-8901EN	Determination of Trace Metal Impurities in Semiconductor Grade Phosphoric Acid by High Sensitivity Reaction Cell ICP-MS
5988-6190EN	Techniques for the Analysis of Organic Chemicals by ICP-MS
5988-7100EN	Direct Analysis of Photoresist by ICP-MS

## Clinical and Pharmaceutical

Typical applications of ICP-MS include:

- The determination of trace elements in urine, blood and serum (clinical toxicology and also pharmaceutical drug trials)
- Analysis of heavy metals and/or metal species in drug product bulk materials and intermediates

Elemental concentrations may be measured in body fluids and tissues in order to study occupational exposure, infection, poisoning and the treatment of disease. ICP-MS offers rapid multi-element analysis at very low concentrations with isotopic capability and is favored for many routine and research applications in this field. As well as monitoring of trace elements in body fluids [1, 2, 3] and other tissues [4], isotope ratio measurement is of great interest, where stable isotopes can be used to mark or label compounds of interest, which then act as tracers as they pass through the body [5, 6].

Trace metal analysis of clinical samples may be required for routine determination of exposure levels for toxic heavy metals (typically Cd, Hg and Pb), elements associated with occupational (Cr, Ni, Pt), or dietary exposure (Sn, Hg) and essential elements (such as I and Se) where insufficient dietary intake may lead to clinical deficiency. Other elements may be used as indicators of renal failure or other disease, while levels of trace elements may be important in certain clinical treatments, such as Al in the pure water used for kidney dialysis. The development of CRC-ICP-MS has greatly improved the determination of previously difficult elements such as Cr, As and Se in biological materials, allowing accurate determination even at the low levels at which these elements may be found in un-exposed patients. [7].

An example application of the 7500ce includes the development of a robust method for the high sample throughput analysis of a large suite of elements in whole blood and serum matrices following simple dilution in an alkaline diluent containing ammonium hydroxide, EDTA, Triton X-100 and butan-1-ol [8]. Due to the robust plasma of the 7500ce, no sample matrix matching is required, with the calibration standards simply being prepared in the sample diluent solution. This approach has the added benefit of matching the carbon content of samples and standards, thereby ensuring consistent ionization for poorly ionized elements such as As and Se. The robustness of the methodology can be demonstrated by overlaying three calibration curves for Se and Pb from the beginning, middle, and end of the 10-hour run – see Figure 5. The correlation coefficients for the mean slope ranged from 0.9997 to 1.0000 with individual calibration coefficients generally better than  $r^2 > 0.9900$ .

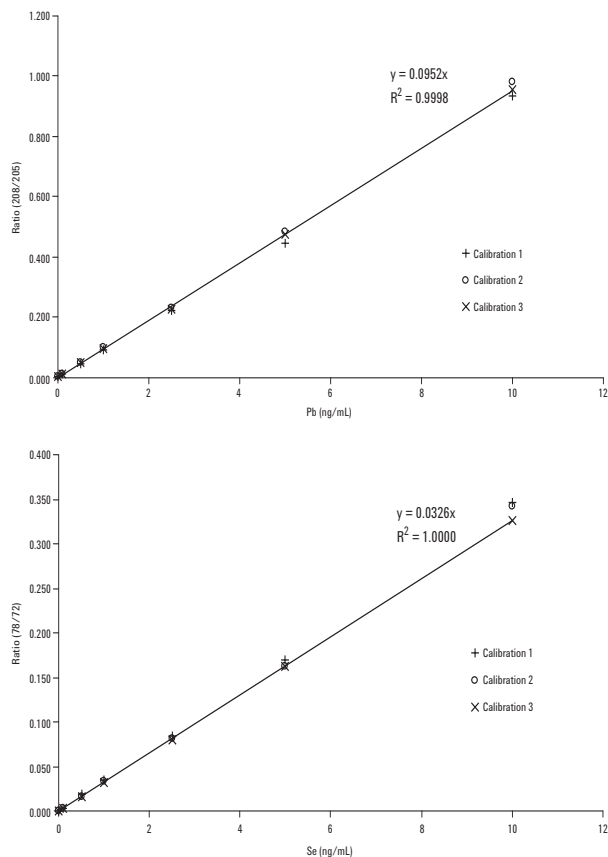

**Figure 5:** Linearity of overlaid calibration curves for Se and Pb showing stability of the calibration throughout a 90-sample sequence.



In the pharmaceutical industry, analysis of potentially harmful metals (US Pharmacopoeia heavy metals) is required in drug product bulk materials. There is also a diverse range of applications for trace metal analysis in drug development and testing, utilizing high performance liquid chromatography (HPLC) to separate species prior to ICP-MS analysis. Currently the focus is on speciation measurement of S and P for drug metabolism and phosphorylation studies.

## References

1. Vandecasteele, C., Vanhoe, H. and Dams, R., 1993, *J. Anal. Atom. Spectrom.*, 8, 781-786
2. Sieniawska, C. E., Mensikov, R. and Delves, H. T., 1999, *J. Anal. Atom. Spectrom.*
3. Heitland, P., *Rapid and Reliable Routine Analysis of Urine by Octopole Reaction Cell ICP-MS*, 2005, Agilent pub 5989-2482EN
4. Roberts, N. B., Walsh, H. P. J., Klenerman, L., Kelly, S. A. and Helliwell, T. R., 1996, *J. Anal. Atom. Spectrom.*, 11, 133-138
5. Whittaker, P. G., Barrett, J. F. R. and Williams, J. G., 1992, *J. Anal. Atom. Spectrom.*, 7, 109-115
6. Janghorbani, M. and Ting, B. T. G., 1990, *J. Nutr. Biochem.*, 1, 4-19
7. Marchante-Gayon, J. M., Feldmann, I., Thomas, C. and Jakubowski, N., 2001, *J. Anal. Atom. Spectrom.*, 16 (5), 457-463
8. Wahlen, R., Evans, L., Turner, J., Hearn, R., *The Use of Collision/Reaction Cell ICP-MS for the Simultaneous Determination of 18 Elements in Blood and Serum Samples*, 2005, Agilent pub 5989-2885EN

## Geological

Typical applications of ICP-MS include:

- Characterization of rocks and minerals
- Screening samples in mining exploration, product quality and ore processing
- Isotope ratio measurements for geochronology

Measurements of trace elements in geological materials were among the first applications of ICP-MS [1]. The low detection limits, multi-element capability and simple ICP-MS spectra, particularly for elements with complex emission spectra such as the rare earth elements (REE) [2] led to the widespread use of the new technique for geochemical analysis. In addition to the determination of trace element levels in bulk rock and mineral samples [3], ICP-MS has been applied very successfully to the study of the distribution of elements in geological materials, using laser ablation (LA) for the direct solid sampling of natural rock samples and thin sections [4]. The development of new lasers operating in the far UV region has allowed LA-ICP-MS to analyze even transparent and easily cleaved minerals such as quartz, mica and calcite [5].

While quadrupole based ICP-MS cannot match the precision obtained by dedicated isotope ratio techniques such as Thermal Ionization Mass Spectrometry (TIMS), it is faster and much less expensive. Laser sampling (LA-ICP-MS) removes the need for lengthy sample preparation making the technique considerably more productive.

Some crystalline materials can be analyzed and the data used to measure their age. Zircons are an excellent example;  $^{207}\text{Pb}/^{235}\text{U}$  and  $^{206}\text{Pb}/^{238}\text{U}$  ratios can be used to determine age of the material [6].

### AGILENT LITERATURE – CLINICAL AND PHARMACEUTICAL

5989-2885EN	The Use of Collision/Reaction Cell ICP-MS for the Simultaneous Determination of 18 Elements in Blood and Serum Samples
5989-2482EN	Rapid and Reliable Routine Analysis of Urine by Octopole Reaction Cell ICP-MS
5968-3050E	Speciation of Arsenic Compounds in Urine of Dimethylarsinic Acid Orally Exposed Rat by Using IC-ICP-MS
5968-8185EN	Determination of Platinum Compounds by LC-ICP-MS

Applying LA-ICP-MS to the analysis of corals has led to a greater understanding of the role of the oceans in the dynamics of the Earth's climate. Researchers collected long coral cores, spanning several centuries, from various locations throughout the globe and analyzed them using LA-ICP-MS. The technique provided rapid results for B, Mg, Ca, Mn, Zn, Sr, Ba and U concentrations simultaneously with appropriate spatial resolution regardless of coral growth rate. Previously, long time-series studies with monthly resolution or better have been very time consuming and prohibitively expensive. The accuracy of LA-ICP-MS was checked by comparing results for Sr/Ca and Ba/Ca concentrations of bulk powders against those measured in solution by isotope dilution ICP-MS. The LA-ICP-MS and solution measurements agreed within the statistical error (Figure 6). Using a pressed powder standard constructed from a calibrated coral provides accurate fully quantitative LA-ICP-MS for CaCO<sub>3</sub> (corals and sponges) with differing concentrations.

In mining exploration, ICP-MS is used to screen very large numbers of samples to look for potential ore deposits. In Western Australia, contract labs supporting the mining industry use the 7500 Series with ISIS for ultra high sample throughput, screening several hundred samples per day with a sample to sample time of about 50 seconds.

## References

1. Date, A. R. and Gray, A. L., 1985, Spectrochim. Acta, 40B, 115-122
2. Jarvis, K. E., 1988, Chem. Geol., 68, 31-39
3. Garbe-Schoenberg, C. D., 1993, Geostand. Newsl., 17, 81-97
4. Pearce, N. J. G., Perkins, W. T., Abell, I., Duller, G. A. T. and Fuge, R., 1992, J. Anal. Atom. Spectrom., 7, 53-57
5. Jeffries, T. E., Jackson, S. E. and Longerich, H. P., 1998, J. Anal. Atom. Spectrom., 13, 935-940
6. Jackson S.E, Pearson NJ, Griffin WL and Belousova EA Chem Geo, 211 (2004), 47-69

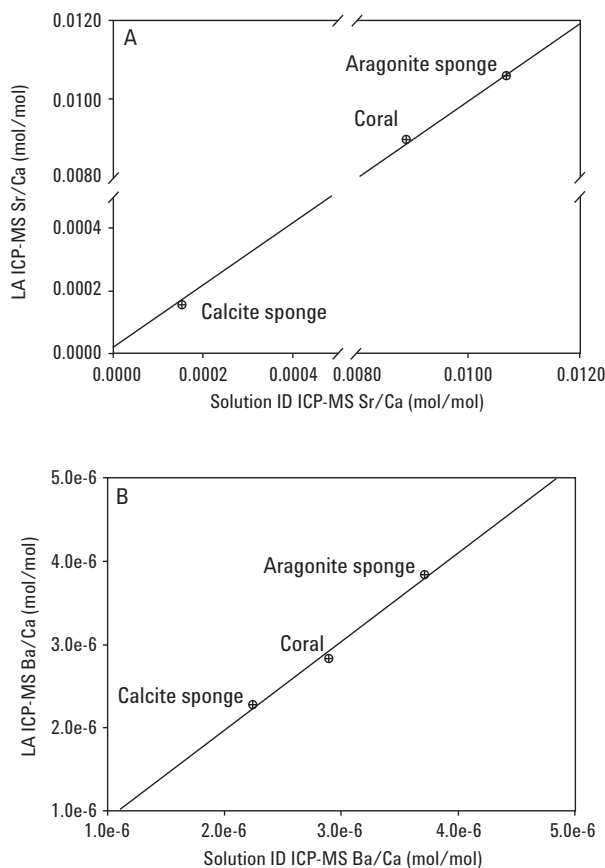

**Figure 6:** Accuracy of LA-ICP-MS method. Comparing solution Isotope Dilution (ID) ICP-MS (x axis) with LA-ICP-MS (y axis) of three samples: a calcite sponge, a coral, and an aragonite sponge

## AGILENT LITERATURE – GEOLOGICAL

5989-1266EN	A New Technique for the Analysis of Corundum using Laser Ablation ICP-MS
5988-6305EN	Analysis of Rare Earth Elements in Geological Samples by LA-ICP-MS
5988-3742EN	Measuring Elemental Ratios in Corals by LA-ICP-MS

## Nuclear

The principal applications of ICP-MS in nuclear applications are:

- Nuclear fuel production: impurity analysis of fuels intermediate compounds (UF<sub>6</sub>, UO<sub>2</sub>, U<sub>3</sub>O<sub>8</sub>) and fuel cladding materials
- Nuclear power plants: monitoring of primary cooling water for corrosion and monitoring of moderator (boron) isotope ratio
- Effluent discharge monitoring
- Monitoring of workforce – clinical sampling and workplace monitoring (air sampling)

Due to its excellent DLs for rare earth elements (REE), and freedom from interferences with U matrices (compared to ICP-OES), ICP-MS was adopted quickly by the nuclear industry in the mid 1980's. REEs are high neutron cross-section elements and so nuclear fuel intermediates must be checked to ensure they are REE-free before being used in fuel production. ICP-MS is a perfect tool for this work: ICP-OES cannot be used since REE and U emission spectra are extremely complex, preventing measurement of REE at low levels. More recently, ICP-MS has been widely adopted by nuclear power stations of the pressurized water reactor (PWR) type. ICP-MS is ideally suited to the monitoring of a variety of corrosion products (principally Fe) in the primary cooling water circuit, giving advanced warning of any pipework corrosion. In these power stations, the same ICP-MS is frequently also used for monitoring the <sup>10</sup>B/<sup>11</sup>B ratio of boric acid added to cooling waters as a moderator.

**Table 2:** Detection limits (3-sigma) for selected elements in a 5000 ppm boron matrix – from primary cooling water circuit. \*Fe DL elevated due to blank level in matrix.

ELEMENT	MASS	DETECTION LIMITS (PPT)	PLASMA
Cr	52	15	Cool
Mn	55	6	Cool
Fe	56	15*	Cool
Ni	58	3	Cool
Cu	65	1	Cool
Mo	98	1	Normal

Table 2 shows the performance of cool plasma (Agilent 7500a) for measuring corrosion products in primary cooling water containing 5000 ppm B. This application is an unusual one for cool plasma ICP-MS, but is one that demonstrates its applicability to high matrix samples in certain cases. Equally the 7500ce ORS can be applied to this application, but cool plasma was widely adopted by the German nuclear industry prior to the development of CRC-ICP-MS.

## Forensic

Typical applications of ICP-MS include:

- Accurate measurement of elemental “fingerprint” in crime scene evidence to characterize and identify materials
- Discriminating elemental and isotopic differences of solid samples directly at the part per billion level using laser ablation LA-ICP-MS

The application of trace metal analysis in forensic science has received less attention and investment than the parallel science of biological sample analysis (DNA fingerprinting). However, there are many instances where the elemental concentration, elemental ratio or isotopic composition of the elemental content of a sample can provide conclusive evidence of its source. Trace element composition can be used in applications including the fingerprinting of gold samples to identify the source of natural or refined gold [1], identification of gunshot residues and differentiation

### AGILENT LITERATURE – NUCLEAR

5965-5181EN	Practical Benefits of an Ultra Sensitive ICP-MS System - Actinide Determination at the PPO Level
5966-1957EN	Analysis of Boron in Uranium Matrix by ICP-MS
5966-1952EN	The Analysis of Trace Elements in Boric Acid by ICP-MS
5989-4393EN	Analysis of Non-Nuclear Samples in Nuclear Power Plants by ICP-MS
5965-5148EN	The Determination of Technetium in a Uranic Matrix Using ICP-MS
5963-7529EN	Uranium Isotope Ratios and Detection Limits by ICP-MS

between glass fragments with identical refractive indices [2, 3]. Many other types of "scene of crime debris" may be suitable for analysis by LA-ICP-MS, where trace element pattern matching may be more important than any quantification of the sample components. Liquid sample analysis may be appropriate in some cases, such as in suspected poisoning, but laser ablation ICP-MS has enormous potential in forensic applications, where the sample size may be small, and other physical and chemical tests may need to be carried out on the same sample, and where destructive testing is not an option.

An example is the analysis of glass shards from a crime scene [2]. When glass is shattered, the fragments created can be less than a few hundred microns (<0.2 mm). These fragments can become attached to clothing and embedded in shoes, "tagging" anyone present with a unique marker. As glass production methods become increasingly standardized, it is becoming more difficult to distinguish between different glasses using the traditional techniques which rely on physical parameters, such as refractive index (RI). As a result, new instrumentation is needed capable of resolving differences in the trace elemental profiles of similar glasses. LA-ICP-MS is an effective tool for this analysis. This technique is particularly useful in overcoming the limitations associated with very small sample types or samples composed of chemically inert materials. Colorless glass fragments may be discriminated with good accuracy and precision, even at sub-millimeter dimensions.

Furthermore, LA-ICP-MS data can be presented in a clearly understandable format to aid jurors with little or no scientific background to decipher subtle chemical differences between evidentiary materials. Figure 7 shows glass data presented as a stacked bar graph; an extremely effective way to compare different multi-component data sets.

## References

1. Watling, R. J., Herbert, H. K., Delev, D. and Abell, I. D., 1994, Spectrochim. Acta, 49B (2), 205-219
2. Neufeld, L., Analysis of Forensic Glass Samples by Laser Ablation ICP-MS, 2004, Agilent pub 5989-1567EN
3. Montero, S., Hobbs, A., French, T., and Almirall, J.R., Elemental profiling of glass fragments by ICP-MS as evidence of association: analysis of a case", Journal of Forensic Sciences, 2003, 48(5) 1101-1107.

**Figure 7:** The mean data from the analysis of standard glass fragments (612, 1831, 620, 621) and car headlight fragments (C, A, B) is presented in a stacked bar chart format. This visual representation of the data aids data presentation in terms of clarity and relative simplicity.

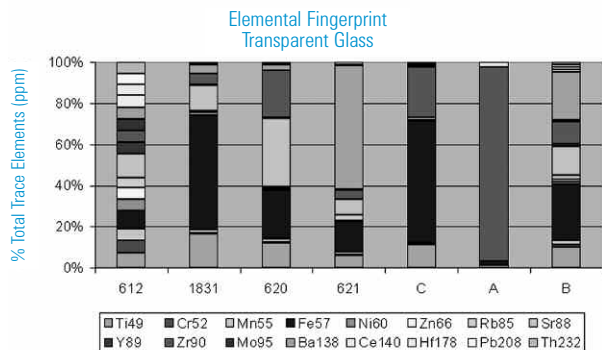

## AGILENT LITERATURE – FORENSICS

- 5989-1565EN Introduction to Laser Ablation ICP-MS for the Analysis of Forensic Samples
- 5989-1567EN Analysis of Forensic Glass Samples by Laser Ablation ICP-MS
- 5989-1566EN Methods for the Forensic Analysis of Adhesive Tape Samples by Laser Ablation ICP-MS

## Chemical, Petrochemical

Typical applications of ICP-MS include:

- Analysis of trace metal concentrations in petrochemical samples
- Trace element levels in printer ink
- Speciation measurement of petrochemical samples using GC-ICP-MS

Traditionally ICP-MS has not been considered as the most appropriate technique for the measurement of trace metals in organic matrices due to the perceived problems with sample introduction, plasma stability, carbon deposition on the interface, and the formation of carbon-based interferences. The key point is good ICP RF generator design (see section 2) which enables a stable plasma to be maintained, even when sample volatility varies widely. In addition, careful choice of sample introduction configuration is required to ensure trouble free organics analysis [1]. The 7500 Series is in routine use worldwide in petrochemical labs analyzing the full range of sample matrices from very heavy fractions through to kerosene and naphtha. Figure 8 shows calibration plots (method

of standard additions) obtained from the direct analysis of gasoline using the 7500ce in non-gas mode and H<sub>2</sub> gas mode. The efficiency of H<sub>2</sub> mode for the removal of the intense C<sub>2</sub> interference on Mg at m/z 24 can clearly be seen in Figure 8b.

Increasing interest is being shown in speciation measurement in petrochemical samples using GC as the separation technique [2]. For example, knowing the species of sulfur present helps petrochemical companies to better design processes to remove sulfur more efficiently from the product stream (low-sulfur gasoline, diesel and fuel oil).

## References

1. McCurdy, E., Woods, G. D. and Mizobuchi, K., 2001, Practical Considerations in the Routine Analysis of Organic Solvents by ICP-MS, paper O-9 presented at the European Winter Conference on Plasma Spectrochemistry, Hafjell, Norway, 4-8 February, 2001
2. Bouysiere, B., Bako, F., Savary, L. and Lobinski, R., 2000, Oil Gas Sci. Tech. Rev. IFP, 55 (6), 639-648

**Figure 8a (left):** Magnesium calibration (no-gas mode) - note apparent concentration of 196.6 µg/kg due to C<sub>2</sub> interference.

**Figure 8b (right):** Magnesium calibration (H<sub>2</sub> mode) - note Mg concentration of 9.24 µg/kg

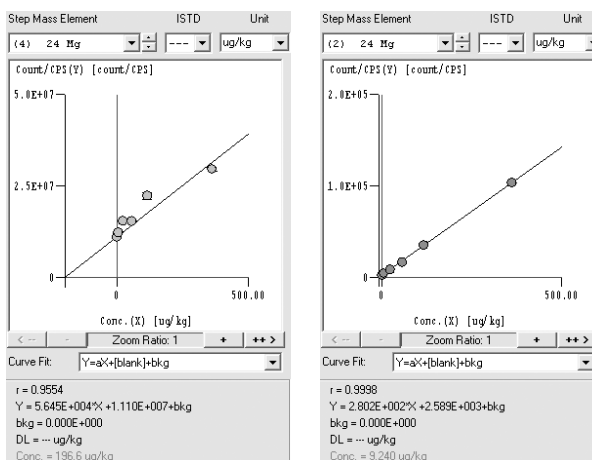

## AGILENT LITERATURE – CHEMICALS, PETROCHEMICAL

5989-4147EN	Direct Analysis of Gasoline by Agilent 7500ce ORS ICP-MS
5988-6190EN	Techniques for the Analysis of Organic Chemicals by Inductively Coupled Plasma Mass Spectrometry (ICP-MS)
5988-9880EN	Quantification and Characterization of Sulfur in Low-Sulfur Reformulated Gasolines by GC-ICP-MS
5966-3068EN	The Determination of Vanadium and Nickel in Heavy Oil by ICP-MS



## Section 8 – Operating Costs, Maintenance and Diagnostics



As ICP-MS has evolved into a mature, routine technique, so the mechanical, electronic and software components of the instrumentation have developed to produce compact, high performance and easy to use systems that meet the day to day needs of every analytical lab. In routine, high throughput laboratories, the support and maintenance aspects associated with operating the instrument can be of equal importance to its analytical performance. The ongoing cost of consumables and instrument repair contracts is also a factor to consider when choosing an ICP-MS. Because ICP-MS manufacturers base the price of service contracts on the cost to provide the service, more reliable ICP-MS systems will have lower service contract prices.

## Routine Maintenance Schedule

Regular maintenance of the ICP-MS will serve to extend the useful life of its components and optimize its analytical capabilities. The actual maintenance schedule implemented in a lab will depend on the number and type of samples analyzed. The information provided in Table 1 is intended to give potential ICP-MS users an idea of the key maintenance tasks required to operate a typical ICP-MS by recommended task frequency. The information is based on the Agilent 7500 Series.

**Table 1:** Summarized maintenance schedule for 7500 Series

FREQUENCY	COMPONENT	TASK
Daily	Argon gas supply	Check gas pressure and supply
Daily	Peristaltic pump tubing	Check for wear
Daily	Sampling cone/Skimmer cone	Check orifice visually
When needed	Sampling cone/Skimmer cone	Clean/replace
When needed	Nebulizer	Clean/replace
When needed	Torch	Clean/replace
Weekly	Tuning solution prep	–
Weekly	Torch, Spray chamber, End cap	Clean
Weekly	Nebulizer	Clean
Weekly	Cooling water	Check water level
Monthly	Rotary pump	Check oil level and color
Monthly	Sample tubing	Replace
4-6 months	Lenses	Clean
6 monthly	Rotary pump	Change oil
6 monthly	Gas tubings	Replace
Annually	O-rings	Replace
Annually	Penning gauge	Clean
Biennially	Argon gas filter	Replace (2 years after installation)

# Operating Costs, Maintenance and Diagnostics

## Consumables Usage

Consumables usage depends on the number and type of samples analyzed. The typical annual consumables usage for an ICP-MS in an environmental lab running 8 hours/day and 5 days/week would be typically:

- 3-4 sets of interface cones (depends greatly on sample type)
- 1 set of sample introduction glassware
- Peri pump and sample line tubing
- Rotary pump oil
- Detector (the detector on a 7500 Series lasts typically 2-3 years)
- RF Power Tube\* - a new tube will be required every 2 years if the generator is a power tube-based design

\* Agilent 7500 Series has a solid state ICP RF generator so no power tube is used

## Operating Costs: ICP-MS Compared to Other Elemental Techniques

ICP-MS is generally perceived as being a more expensive technique to purchase and run compared to techniques like ICP-OES and GFAAS for the same routine, multielement application. However, costs of consumables for ICP-MS are not that much more expensive than ICP-OES, and cheaper than GFAAS. A detailed look at the costs involved in operating an ICP-MS compared to ICP-OES/GFAAS can be seen in Agilent publication 5989-1585EN [1]. A summary of the return on investment calculation shows that depending on the number of samples, the payback for the ICP-MS can be as short as a few months, despite the higher outlay costs of the ICP-MS.

## Maintenance and Diagnostics

The facility to predict routine maintenance is essential to maximize the efficiency of the laboratory, as is the ability to monitor both laboratory and instrument conditions to assist the diagnostics of potential problems.

**Figure 1:** Example of 7500 Series ICP-MS instrument maintenance log showing the running times of various components and the total ions measured by the detector, which is used to predict remaining lifetime of the detector.

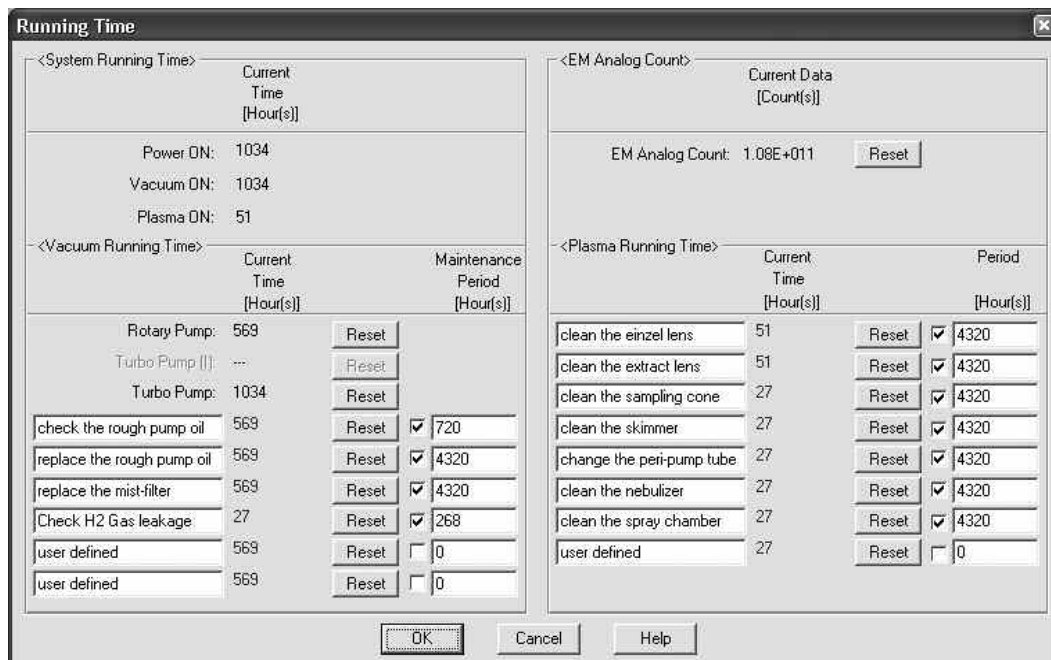



## Instrument Maintenance Log

An example of ongoing monitoring by the ICP-MS software is the constant logging of the instrument run time. The Agilent ICP-MS ChemStation software notifies the operator when a basic maintenance procedure (see Figure 1) should be performed based on the operating hours of a particular component; the warning set point times can be customized to accommodate any laboratory standard operating procedure (SOP). The 7500 Series instrument maintenance log provides an electronic day-to-day snapshot of basic instrument performance and maintenance activities performed by the ICP-MS operator.

## Diagnostics

If a problem does arise with the ICP-MS hardware or software, there is a high probability that one of the instrument meters will locate and report the problem. For example the 7500 Series software has the ability to monitor 106 instrument parameters to help with the maintenance and diagnostics. The problem could then be solved by lab personnel directly or with guidance through telephone support with a manufacturer's specialist. Another option is to use the remote diagnostics facility of the ICP-MS which allows a support specialist to view your desktop and, with permission, interact with your system. With this approach, support specialists can often diagnose and resolve faults quickly, minimizing down-time or at least identify the problem in advance of an on-site visit.

## References

1. A Comparison of the Relative Cost and Productivity of Traditional Metals Analysis Techniques versus ICP-MS in High Throughput Commercial Laboratories, Agilent Application Note, 2004, 5989-1585EN



## Section 9 – Legislated ICP-MS Methods



Most countries have strict legislation governing acceptable levels of inorganic constituents in samples typical of a wide range of activities, including environmental, food safety, clinical and manufacturing industries. The purpose of setting tough standards is primarily to restrict pollution and to protect public health and the environment. The legislation adopted is often based on international or US standards. Examples include environmental guidelines published by the European Union (EU) and US Environmental Protection Agency (US EPA); semiconductor and manufacturing standards recommended by Semiconductor Equipment and Materials International (SEMI); and food standards specified in the Codex Alimentarius by the Food and Agriculture Organization (FAO) of the World Health Organization (WHO).

In order to adhere to the legislated limits for the trace element content of samples relating to their particular field of work, most laboratories require instruments that deliver limits of quantification that are at least 10 times lower than the required value and typically have used methods based on ICP-OES and GFAAS.

However, with improvements in ICP-MS technology (robustness, matrix tolerance, linear range, reduction in interferences) and its wider acceptance across more industries over the past 20 years, ICP-MS is now replacing the multi-technique approach in many labs. This trend is also being fuelled by the downward pressure on regulatory

levels and rise in the number of legislated methods that recommend the use of ICP-MS, or are performance-based, rather than technique-specific methods.

For example, the National Environmental Methods Index ([www.nemi.gov](http://www.nemi.gov)) – a methods resource website sponsored by the US EPA and US Geological Survey (USGS) – currently lists eleven approved ICP-MS methods by various agencies within the US. Five have been developed by the US EPA for various applications and matrices. Two, EPA 200.8 and EPA 6020 are specified for regulatory compliance for drinking water and waste samples.

Commonly used US-EPA methods for ICP-MS:

- Method 200.8 (Drinking Water)
- Method 6020 (Wastewater, Solid Waste)
- Method 6020A (Added Elements, Draft Status)
- Method 1638 (Ambient Water, Low Level Trace)

## Approved ICP-MS Methods Resource

Agilent has developed a series of web pages aimed at keeping analysts abreast of changes to, or introductions of approved ICP-MS methods. Visit the Agilent ICP-MS web site at: [www.agilent.com/chem/icpms](http://www.agilent.com/chem/icpms) and look for the link to “ICP-MS Methods News” under Additional Information towards the bottom of the page.

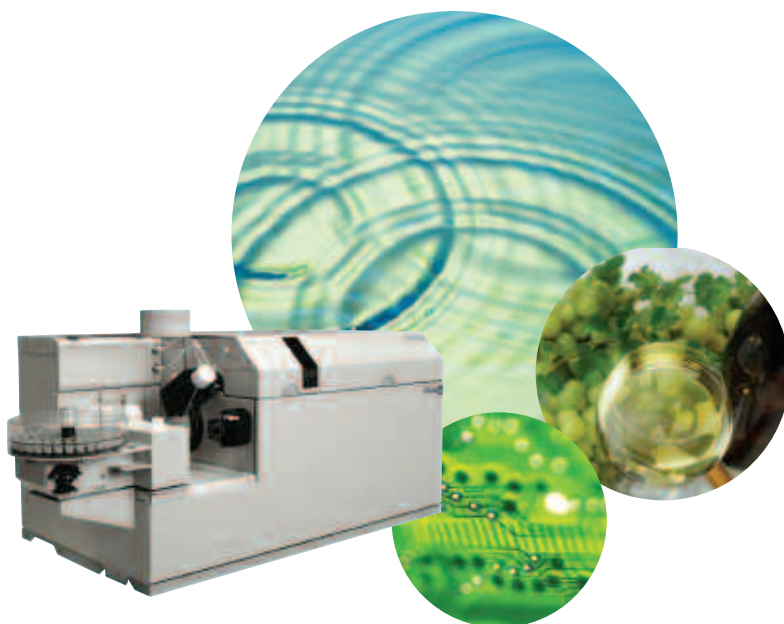

For more information, please visit  
[www.agilent.com/chem/icpms](http://www.agilent.com/chem/icpms)

Reproduction, adaptation, or translation without prior written permission is prohibited, except as allowed under the copyright laws. This information is subject to change without notice.

© Agilent Technologies, Inc. 2005  
Printed in USA December 2005

Publication Number 5989-3526EN



**Agilent Technologies**